

Three-Color Passive-Matrix Pixels Using Dye-Diffusion-Patterned Tri-Layer Polymer-Based LED

Ke Long, Florian Pschenitzka and J. C. Sturm

Center for Photonics and Optoelectronic Materials (POEM), Department of Electrical Engineering, Princeton University, Princeton, New Jersey 08544

ABSTRACT

Dry dye-printing and solvent-enhanced dye diffusion were used to locally dope a previously spin-coated poly(9-vinylcarbazole) (PVK) polymer film with different dyes to fabricate side-by-side RGB OLED pixels. To reduce reverse leakage current and raise efficiency, a blanket tris-8-hydroxyquinoline aluminum (Alq) electron transport layer (ETL) was deposited over the polymer layer after the dye diffusion step, along with a 2,9-dimethyl-4,7-diphenyl-1,10-phenanthroline (BCP) hole/exciton blocking layer between the Alq and the PVK to ensure all light emission occurred from the doped polymer and not from the Alq. Devices with this tri-layer structure have an extremely low reverse leakage current (rectification ratio of 10^6 at ± 10 V) and a higher external quantum efficiency ($\sim 1\%$) than single layer devices. A three-color passive-matrix test array with $300\mu\text{m} \times 1\text{mm}$ RGB subpixels was demonstrated with this structure.

INTRODUCTION

Organic light-emitting devices (OLEDs) are of great interest for flat panel display applications. Passive-matrix is a preferable driving scheme because of its simplicity and low fabrication cost. Polymers are attractive emission materials for OLED displays because they can be deposited by low-cost and high-throughput methods such as spin-coating. However, spin-coating creates blanket layers. For efficient full-color displays, pixels emitting red, green and blue (RGB) colors should be fabricated side by side on the same substrate. Therefore patterning the polymer layer to achieve RGB colors is critical.

The emission colors of polymers can be controlled by adding a small amount of fluorescent dyes into the polymer film (less than 1% by weight) [1]. There are several methods to achieve full color based on this principle, for example ink-jet printing of a dye solution on a previously spin-coated polymer film [2], photobleaching of a dye [3], patterned dye transfer by local heating [4], and thermal transfer through a mask [5]. More recently, we have focused on a local dye transfer process, with two steps, where the dye is first printed onto the device polymer surface using a patterned soft printing plate, followed by diffusion into the polymer film [6]. To lower the temperature required to uniformly diffuse the dye throughout the device polymer from over 100°C to room temperature, a solvent-vapor annealing step has been adopted [7]. The goal of this paper is to extend this transfer process to create RGB devices suitable for a full-color passive matrix.

Conventionally polymer-based OLEDs often consist of only a single polymer layer, sandwiched between anode and cathode. The single-layer dye-doped polymer LED has high leakage current under reverse bias, which is not compatible with passive-matrices because of the cross-talk problem [8]. In this work, a tri-layer device structure is developed to increase efficiency and drastically reduce reverse-bias leakage current. This tri-layer structure and the

solvent-enhanced dye diffusion method are used to fabricate a full color passive-matrix test array.

EXPERIMENTAL DETAILS

Solvent-enhanced dye diffusion

The dry dye-printing method is shown schematically in Figure 1. The OLED device structure consists of a substrate with patterned ITO lines, onto which the polymer is uniformly deposited by spin-coating from a solution to form a 90 nm thick film. The solution contained poly(9-vinylcarbazole) (PVK; M_w ca. 1,100,000 g/mole) as the host polymer and the hole transport material, and the blue dye Coumarin 47 (C47, 0.3% by weight, emission peak at 440nm). The printing plate consists of a pre-patterned dye source layer on a glass substrate. The dye source is a polymer Vylon 103, to which the green dye Coumarin 6 (C6, 2% by weight, emission peak at 500nm) or red dye Nile red (NR, 2% by weight, emission peak at 590nm) were added. The dye-source printing plate was patterned by laminating a pre-patterned soft masking layer to the Vylon, dry etching, followed by removal of the masking layer [6]. The printing plate was aligned to and brought into contact with the device plate in vacuum at 70°C for one hour, to transfer the dyes from the dye source onto the surface of the device polymer. This initial dye transfer step was done once for the green dye and once for the red dye. Then the device sample was put into an acetone vapor ambient for annealing, to diffuse the dyes throughout the bulk polymer film. A uniform dye distribution throughout the polymer film was achieved after annealing in acetone for 150 seconds at room temperature, in a nitrogen atmosphere with 130 ml gaseous acetone per liter of gaseous N_2 [7].

Figure 2 shows a photoluminescence picture of a polymer film with blue, green and red patterns. The blue dye was spin-coated together with the polymer, and the green and red dyes were introduced by solvent-enhanced dye diffusion. 350 μ m-wide red, green and blue color stripes over a 3.5 cm x 2.5 cm area with excellent color uniformity were achieved. There are ITO stripes underneath the polymer layer along with the color stripes. A full color passive-matrix display can be made by evaporating cathode stripes perpendicular to the ITO stripes on the top of the polymer layer. However, the reverse-biased leakage current of these dye-diffused polymer LEDs made with a single layer of 90nm PVK is too high to make devices suitable for passive-matrix application (Figure 3).

Tri-layer device structure

To reduce reverse-bias leakage current and increase the efficiency of single-layer doped polymer LEDs, an electron transport layer (ETL) can be added over the polymer layer after dyes

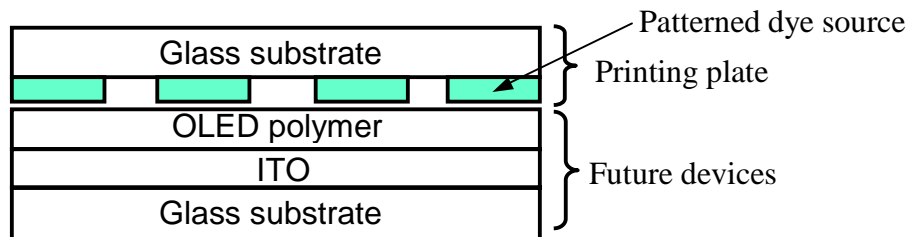

Figure 1. Dye diffusion set-up. OLED polymer was spin-coated from a solution; Dye source is a patterned dye-doped vylon film.

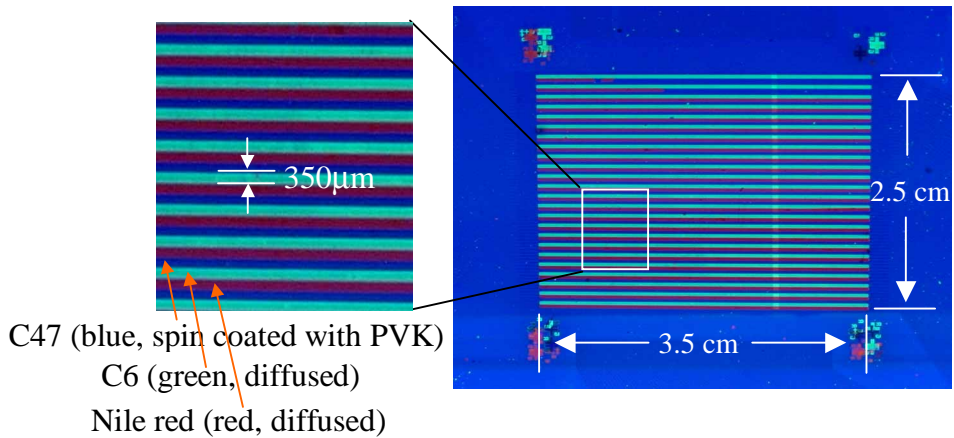

Figure 2. Photoluminescence picture of a PVK film with red, green and blue stripes. Blue dye was spin-coated together with the PVK, green and red dyes were diffused.

have been applied. Tris-8-hydroxyquinoline aluminum (Alq) is a good candidate for this ETL because it has a low HOMO and good electron conductivity. Adding an Alq layer suppresses hole tunneling to reduce reverse leakage current, moves the cathode away from the emissive dyes to reduce cathode-quenching of the excitons via dipole-metal interaction [9], and balances electron and hole transport to raise efficiency. Figure 3 shows the typical I-V characteristics of the single-layer and bi-layer devices. The rectification ratio of the bi-layer devices, defined as the ratio of forward current to reverse current at the same bias, is improved drastically compared to the single-layer device. Also shown are the photo-currents produced by a detector placed close to the devices indicating the brightness of the devices. The efficiency of the bi-layer device is higher than that of the single-layer device.

While the electrical properties of single-layer devices are attractive, the optical emission properties are not. Due to the low exciton energy in the Alq ($E_{\text{exciton}}=2.3\text{eV}$), excitons formed in the polymer layer can migrate to the Alq layer. Furthermore, holes can be injected from the PVK layer into the Alq layer and form excitons with the electrons directly in Alq. These two processes cause the undesired green Alq emission (Figure 4). Therefore the dye in the polymer does not control the emission color. This problem is most serious for blue devices, with the dominant emission from Alq (Figure 5).

To eliminate the OLED color contamination from Alq emission, and confine the light emission within the dye-doped polymer layer, holes and excitons must be prevented from

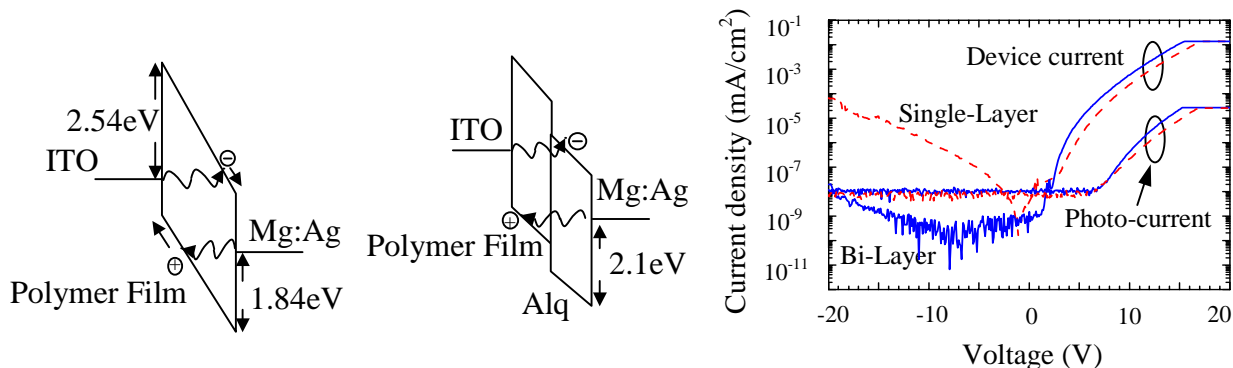

Figure 3. Reverse-bias band diagrams and typical I-V characteristics of the single-layer(90nm PVK) and bi-layer(90nm PVK/40nm Alq) OLEDs. The rectification ratio at ± 10 V increases from $\sim 10^3$ to $\sim 10^6$.

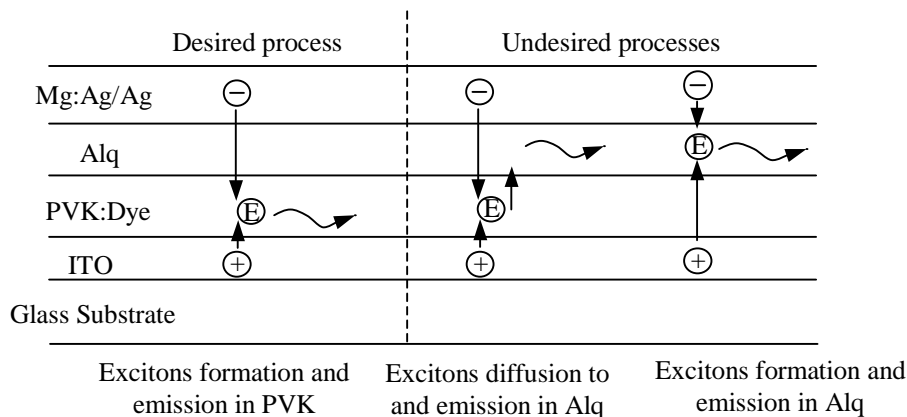

Figure 4. Emission processes in a bi-layer device. Motion of the electrons, holes and excitons is shown.

entering the Alq layer. For this purpose, we used a thin hole/exciton blocking layer (HBL/EBL) between the doped-polymer layer and the Alq layer. 2,9-dimethyl-4,7-diphenyl-1,10-phenanthroline (BCP) is a material that satisfies the bandgap requirement for this hole/exciton blocking layer [10]. As shown in Figure 6, BCP has a low HOMO to block the holes from entering the Alq, and a high bandgap to confine the excitons within the polymer layer. It also has a low enough electron barrier to allow electrons to pass through and enter the polymer layer.

Red, green and blue polymer LEDs have been fabricated with this tri-layer structure. The devices begin with a 90 nm thick polymer blend layer of PVK and a fluorescence dye (Nile red for red devices, Coumarin 6 for green devices, Coumarin 47 for blue devices), which is deposited on top of the ITO layer by spin coating. Then a thin 6 nm BCP layer as an hole/exciton blocking layer and a 40 nm thick Alq layer as an electron transport layer are deposited sequentially by thermal evaporation. A 150 nm thick Mg:Ag (10:1)/Ag layer is deposited as the OLED cathode. Figure 7 shows the electroluminescence spectra of the fabricated blue, green, and red tri-layer devices, with peak wavelengths of 440 nm, 500 nm and 590 nm respectively. Compared with the devices without the BCP layer in Figure 5, the peaks of the red, green, blue devices are well-defined and do not show the contamination of color from the Alq emission. These tri-layer devices have extremely high rectification ratio and a higher efficiency compared to the single-layer devices (Table I).

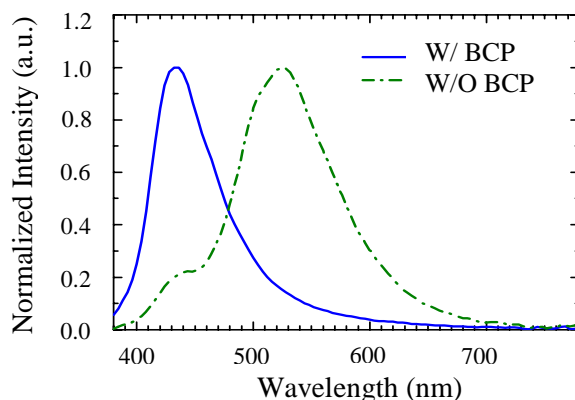

Figure 5. Spectra of the blue devices with and without exciton blocking layer BCP: without the BCP layer, Alq emission (peak @ 524nm, green) dominates; with the BCP layer, only C47 emission (peak @ 440nm, blue) remains.

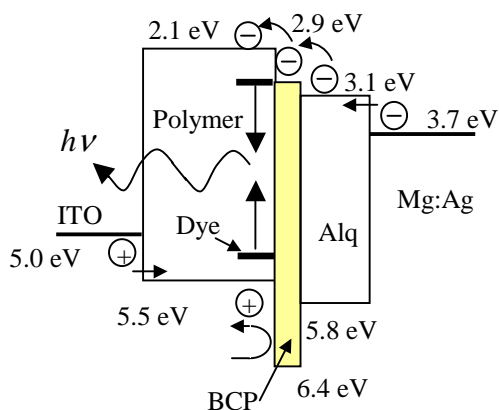

Figure 6. The band diagram of the PVK/BCP/Alq tri-layer structure.

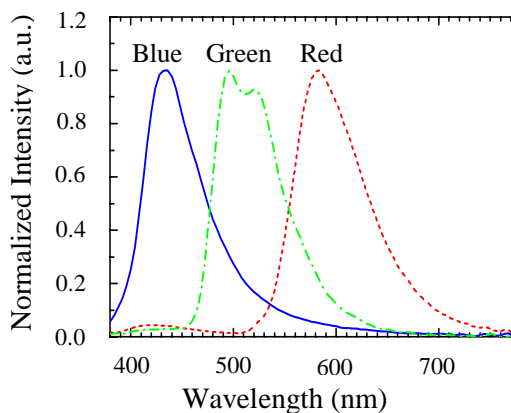

Figure 7. Electroluminescence spectra of the blue, green, and red tri-layer devices. Different emission colors depend on the corresponding dye dopants in the polymer layer: Blue: C47; Green: Coumarin 6; Red: Nile red.

Fabrication of full-color passive-matrix test array

With the solvent-enhanced dye-diffusion method and the tri-layer device structure, we fabricated a full-color passive-matrix test array. First we patterned ITO into 320 μm -wide stripes as column electrodes by wet etching. A blue-doped (C47) PVK layer was spin-coated, followed by C6 (green) and Nile red (red) local printing and a solvent assisted diffusion step. The red, green and blue color stripes were aligned with the ITO stripes. Then a thin 6 nm BCP layer and a 40 nm thick Alq layer were deposited by thermal evaporation on top of the dye-doped PVK layer. At last a 150 nm thick Mg:Ag (10:1)/Ag layer was deposited as the OLED cathode, with a shadow mask to pattern the cathode into stripes perpendicular to the ITO stripes as row electrodes. A 3 row by 15 column three-color passive-matrix test array was fabricated with a 100% pixel yield. Figure 8 shows a schematic diagram of the test array and an optical micrograph of one pixel. Although the cathode contains dark spot defects, the brightness of the individual pixels could be controlled.

SUMMARY

Dry dye printing from a patterned source followed by solvent-enhanced dye diffusion was used to locally dope a previously spin-coated polymer film with different dyes to fabricate

Table 1. Comparison of the single-layer and tri-layer devices.

| | | Blue (Coumarin 47) | Green (Coumarin 6) | Red (Nile red) |
|--|--------------|-----------------------|-----------------------|-------------------|
| η_{ext} (%) | Single-layer | 0.13% | 0.70% | 0.61% |
| | Tri-layer | 0.34% | 1.1% | 0.95% |
| Rectification ratio @ $\pm 10\text{V}$ | Single-layer | 1.5e4 | 1.3e3 | 7.4e3 |
| | Tri-layer | 2.4e6 | 1.3e6 | 8.7e5 |

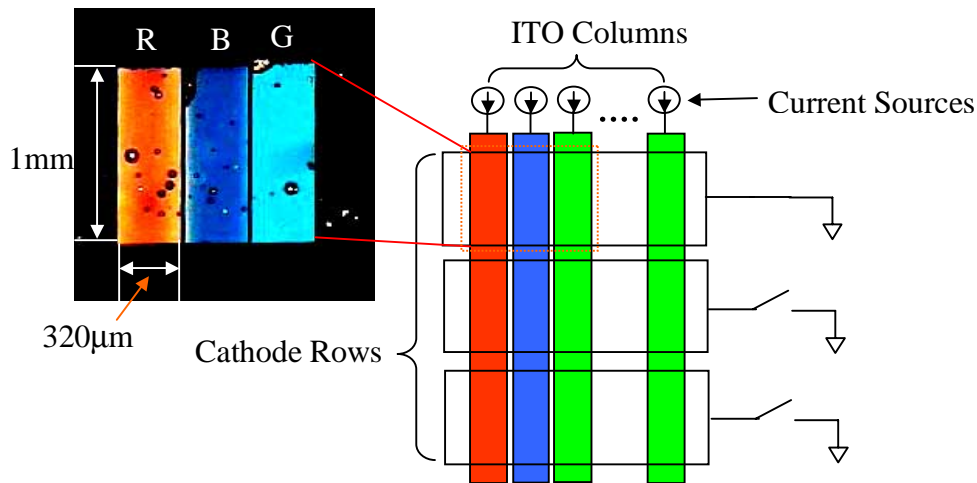

Figure 8. Electroluminescence picture of RGB pixels of the 3 x 15 test array.

side-by-side RGB OLED subpixels for a full color display. To reduce reverse leakage current and raise efficiency, a novel tri-layer OLED structure, which consists of an additional Alq ETL layer and a BCP hole/exciton blocking layer was developed. Devices with this tri-layer structure demonstrate a higher external quantum efficiency (~1%) and an extremely low reverse leakage current (rectification ratio of 10^6 at +/- 10V). The BCP layer confines the light emission to the doped polymer layer. The improved devices will have promising applications in polymer-based OLED displays.

REFERENCES

1. C. C. Wu, J. C. Sturm, R. A. Register, J. Tian, E. P. Dana and M. E. Thompson, *IEEE Trans. Elec. Dev.* **44**, 1269 (1997).
2. T. R. Hebner and J. C. Sturm, *Appl. Phys. Lett.* **73** (13), 1913 (1999).
3. J. Kido, S. Shirai, Y. Yamagata and G. Harada, presented at *Mat. Res. Soc. Symp.*, San Francisco, CA (1999).
4. K. Tada and M. Onoda, *Jpn. J. Appl. Phys.* **38**, L1143 (1999).
5. F. Pschenitzka and J. C. Sturm, *Appl. Phys. Lett.* **74** (13), 1913 (1999).
6. F. Pschenitzka and J. C. Sturm, *Proc. SPIE* **59**, 4105 (2000).
7. F. Pschenitzka and J. C. Sturm, *Appl. Phys. Lett.* **78** (17), 2584 (2001).
8. D. Braun, *Synthetic Metals* **92**, 107 (1998).
9. V. Bulovic, V. B. Khalfin, G. Gu, P. E. Burrows, D. Z. Garbuzov and S. R. Forrest, *Phys. Rev. B* **58**, 3730 (1998).
10. I.G. Hill and A. Kahn, *J. Appl. Phys.* **86**, 4515 (1999).