

**ORF 363/COS 323**

**Computing and Optimization  
in the Physical and Social Sciences**

Amir Ali Ahmadi

Princeton, ORFE

Lecture 1

Fall 2024

# What is optimization?

- Roughly, can think of optimization as the science of making the most out of every situation.
- You've probably all done it many times recently:

## ▪ What courses to take?

- To maximize learning.
- To maximize GPA (?!)
  
- Courses can't conflict.
- Not before 10AM.
- Professor rating > 4.5.

## ▪ What furniture to buy?

- To minimize cost.
- To maximize comfort.
  
- Must fit in your room.
- Must have 3 drawers.
- Not too heavy.

## ▪ What path to choose for a run?

- Maximize probability of encountering your crush(es).
  
- Path must be between 5 and 7 miles.
- Chosen roads must have side walks.
- Path should get you back home.

## ▪ Common theme:

- You make decisions and choose one of many alternatives.
- You hope to maximize or minimize something (you have an objective).
- You cannot make arbitrary decisions. Life puts constraints on you.

# How is this class different from your every-day optimization?

- We'll be learning techniques for dealing with problems that have
  - Thousands (if not millions) of variables
  - Thousands (if not millions) of constraints
- These problems appear every day in the industry, in science, in engineering
- Hopeless to make decisions in your head and with rules of thumb
- Need mathematical techniques that translate to algorithms
  - Algorithms then get implemented on a computer to solve your optimization problem
- We typically model a physical or social scenario with a precise mathematical description
- In this mathematical model, we care about finding *the best solution*
- Whenever we can't find the best solution, we would like to know how far off our proposed solution is

# Examples of optimization problems

## In finance

▪ In what proportions to invest in 500 stocks?

- To maximize return.
- To minimize risk.
  
- No more than 1/5 of your money in any one stock.
- Transactions costs < \$70.
- Return rate > 2%.

## In control engineering

▪ How to drive an autonomous vehicle from A to B?

- To minimize fuel consumption.
- To minimize travel time.
  
- Distance to closest obstacle > 2 meters.
- Speed < 40 miles/hr.
  
- Path needs to be smooth (no sudden changes in direction).

## In machine learning

▪ How to assign likelihoods to transactions being fraudulent?

- To minimize probability of a false negative.
- To penalize overfitting on training set.
  
- Probability of false positive < .15.
- Misclassification error on training set < 5%.

# Computing and Optimization

- This class will give you a broad introduction to “optimization from a computational viewpoint.”
- Optimization and computing are very close areas of applied mathematics:
  - For a host of major problems in computer science, the best algorithms currently come from the theory of optimization.
  - Conversely, foundational work by computer scientists has led to a shift of focus in optimization theory from “mathematical analysis” to “computational mathematics.”
- Several basic topics in scientific computing (that we’ll cover in this course) are either special cases or fundamental ingredients of more elaborate optimization algorithms:
  - Least squares, root finding, solving linear systems, solving linear inequalities, approximation and fitting, matrix factorizations, conjugate gradients,...

# Agenda for today

- Meet your teaching staff
- Get your hands dirty with algorithms
  - Game 1
  - Game 2
- Modelling with a mathematical program
  - Fermat's last theorem!
- Course logistics and expectations

# Meet your teaching staff (1/2)

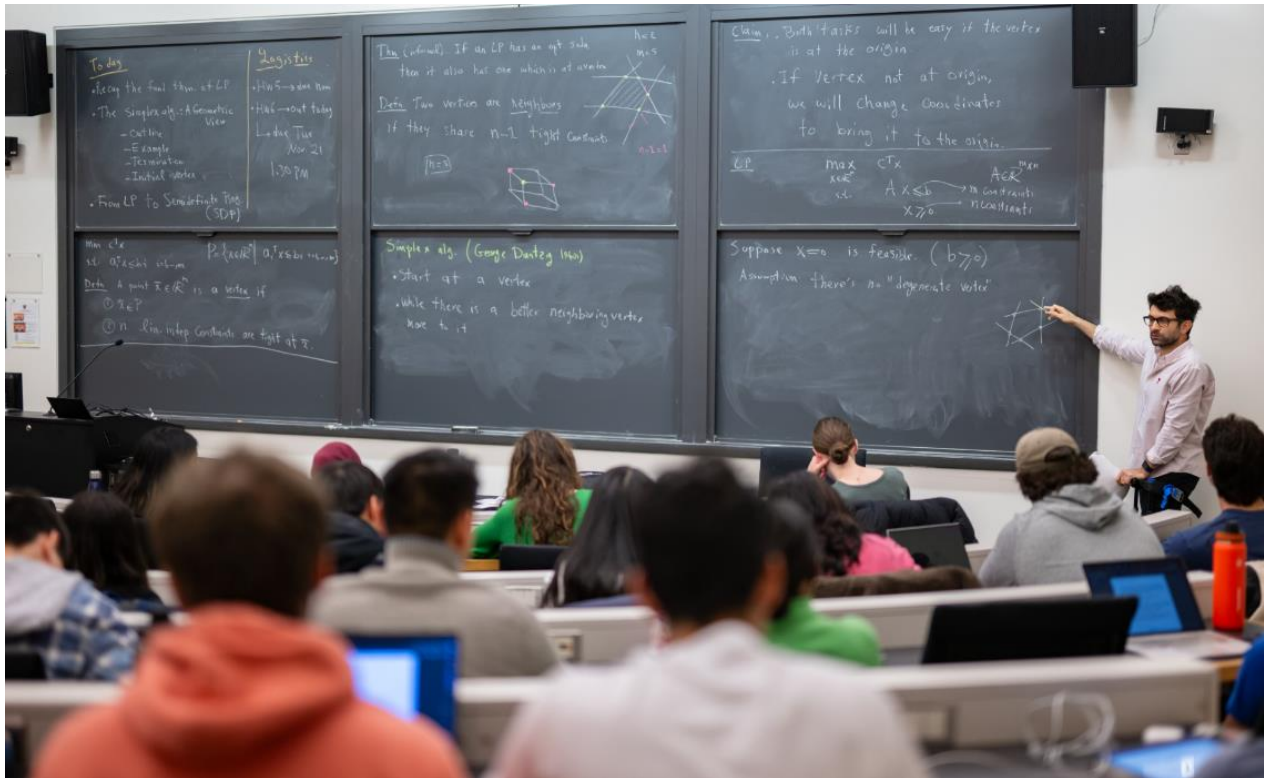

▪ **Amir Ali Ahmadi** (Amir Ali, or Amirali, is my first name)

<http://aaa.princeton.edu/>    [aaa@p...](mailto:aaa@p...)

▪ I am a Professor at ORFE, and affiliated faculty at COS, ECE, MAE, PACM, CSML

▪ I came to Princeton from MIT, EECS, after a fellowship at IBM Research

▪ Office hours: **Wed 4:30-6:30pm, Sherrerd 125**

# Meet your teaching staff (2/2)

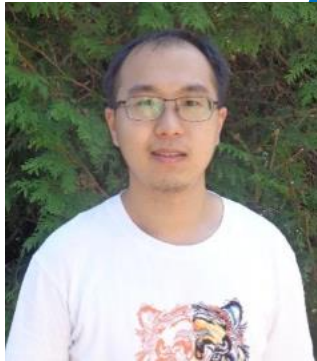

- **Yixuan Hua (AI)** – ORFE grad student
- Office hours: **Mon 7-9pm, Sherrerd 122**  
**Thu 9-11am, Sherrerd 122**

▪ [yh7422@p...](mailto:yh7422@princeton.edu)



- **Burak Aydin (AI)** – ORFE grad student
- Office hours: **Tue 7-9pm, Sherrerd 122**  
**Fri 9-11am, Sherrerd 122**

▪ [ba7735@p...](mailto:ba7735@princeton.edu)



- **Ben Budway (AI)** – ORFE grad student
- Office hours: **Mon 4:30-6:30pm, Sherrerd 122**  
**Wed 7-9pm, Sherrerd 122**

▪ [bb2584@p...](mailto:bb2584@princeton.edu)

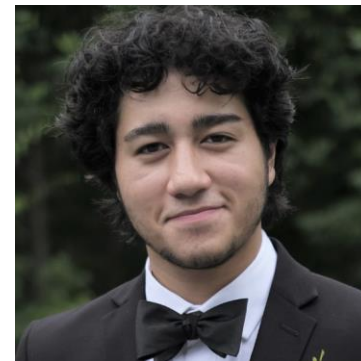

- **George Tziampazis (UCA)** – ORFE senior
- Office hours: **Tue 9-11am, Sherrerd 122**  
**Thu 4:30-6:30pm, Sherrerd 122**

▪ [gt4539@p...](mailto:gt4539@princeton.edu)



# Office hours

Mon	Tue	Wed	Thu	Fri
4:30-6:30pm Sherrerd 122 (Ben)	9-11am Sherrerd 122 (George)	4:30-6:30pm Sherrerd 125 (AAA)	9-11am Sherrerd 122 (Yixuan)	9-11am Sherrerd 122 (Burak)
7-9pm Sherrerd 122 (Yixuan)	7-9pm Sherrerd 122 (Burak)	7-9pm Sherrerd 122 (Ben)	4:30-6:30pm Sherrerd 122 (George)	

# Meet your classmates

ORF 363/COS 323, Fall 2024 (60 registered students)

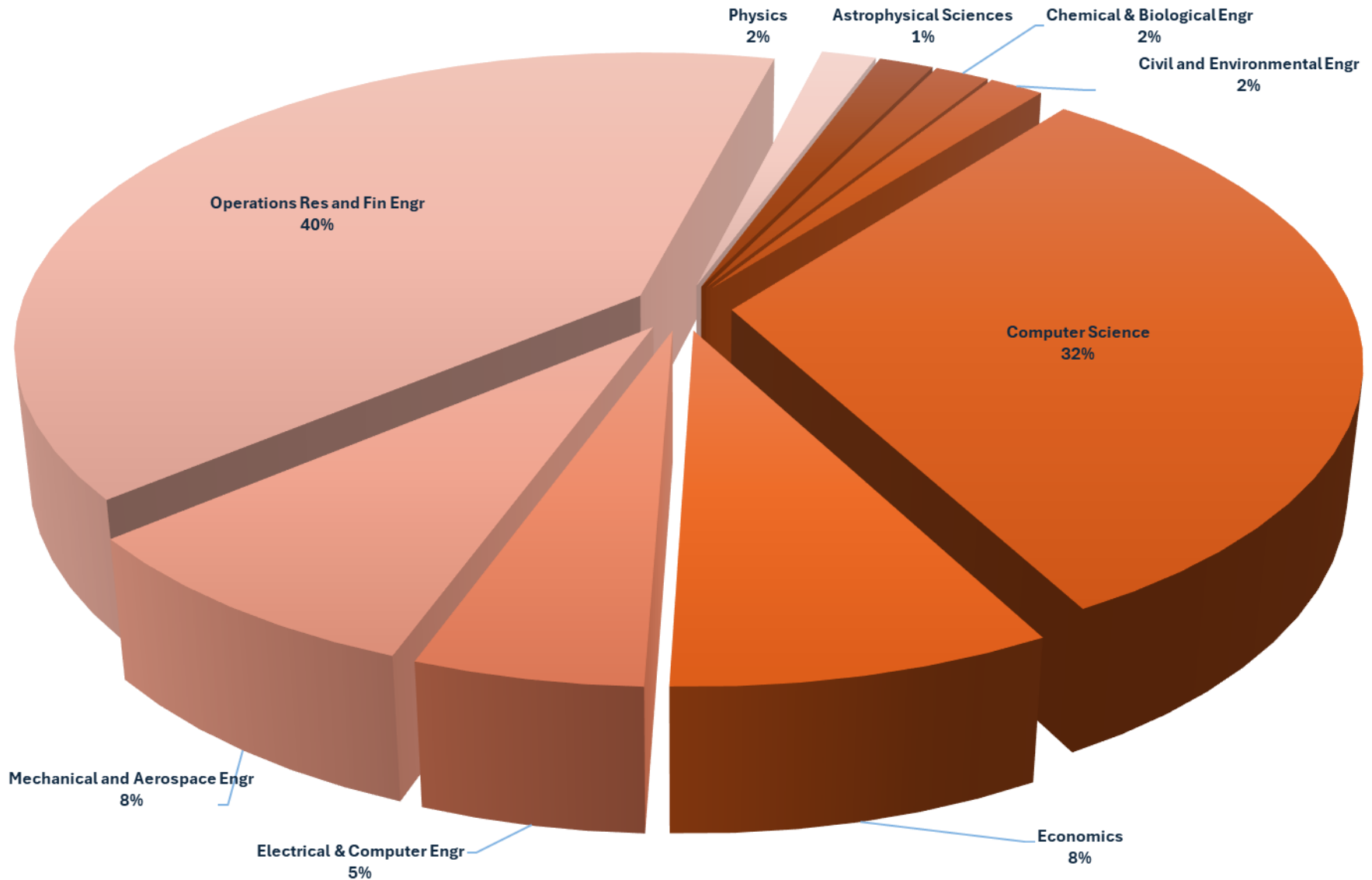

# Course website

Course website:

<http://aaa.princeton.edu/orf363>

- Will have all lectures, problem sets, exams (a copy will also be posted on Canvas)
- Solutions will be posted only on Canvas
- Please set up notification settings on Canvas so you receive our announcements via email
- Please sign up to **Ed Discussion** via Canvas (and use it frequently!)
- Use Ed Discussion instead of email (unless your question is personal)

Let's get to the games!

# Let's ship some oil together!

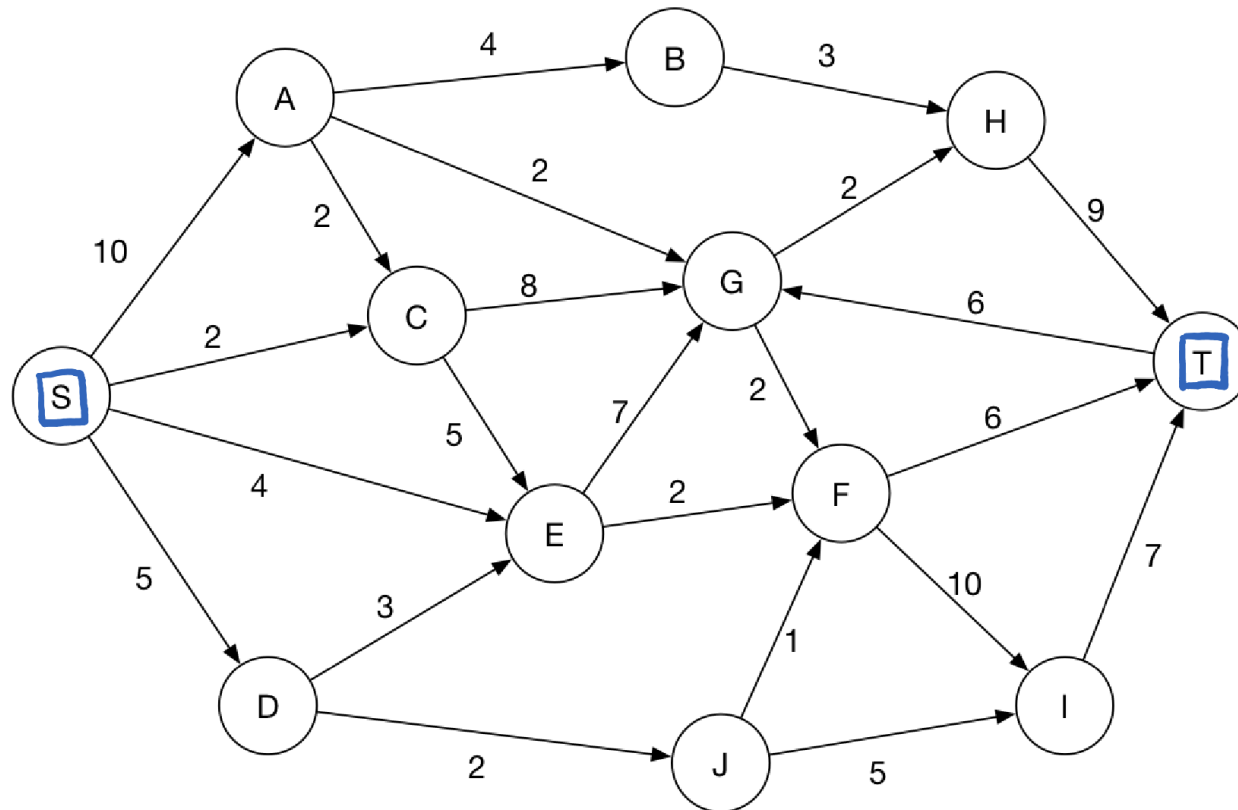

## Rules of the game:

- Cannot exceed capacity on the edges.
- For each node, except for S and T, flow in = flow out (i.e., no storage).
- **Goal:** ship as much oil as you can from S to T.

- Let me start things off for you. Here is a flow with value 9:

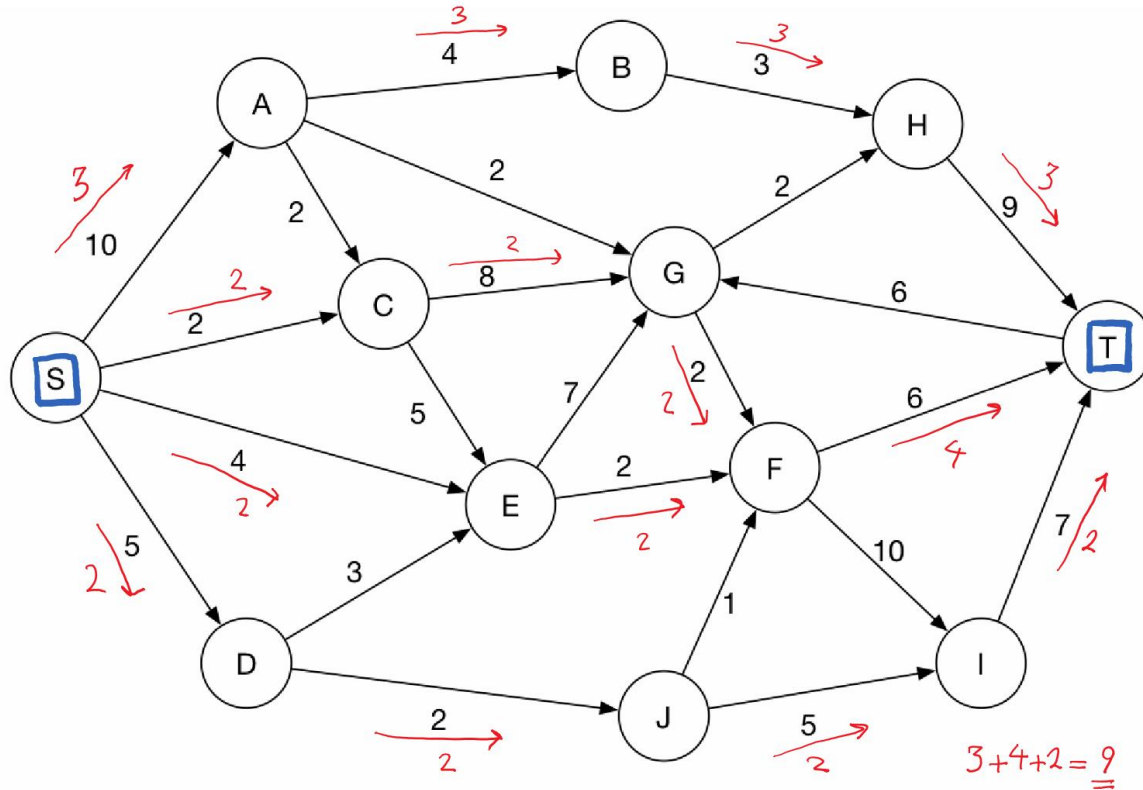

- Can you do better? How much better?
- You all get a copy of this graph.

You have 6 minutes!

# You tell me, I draw...

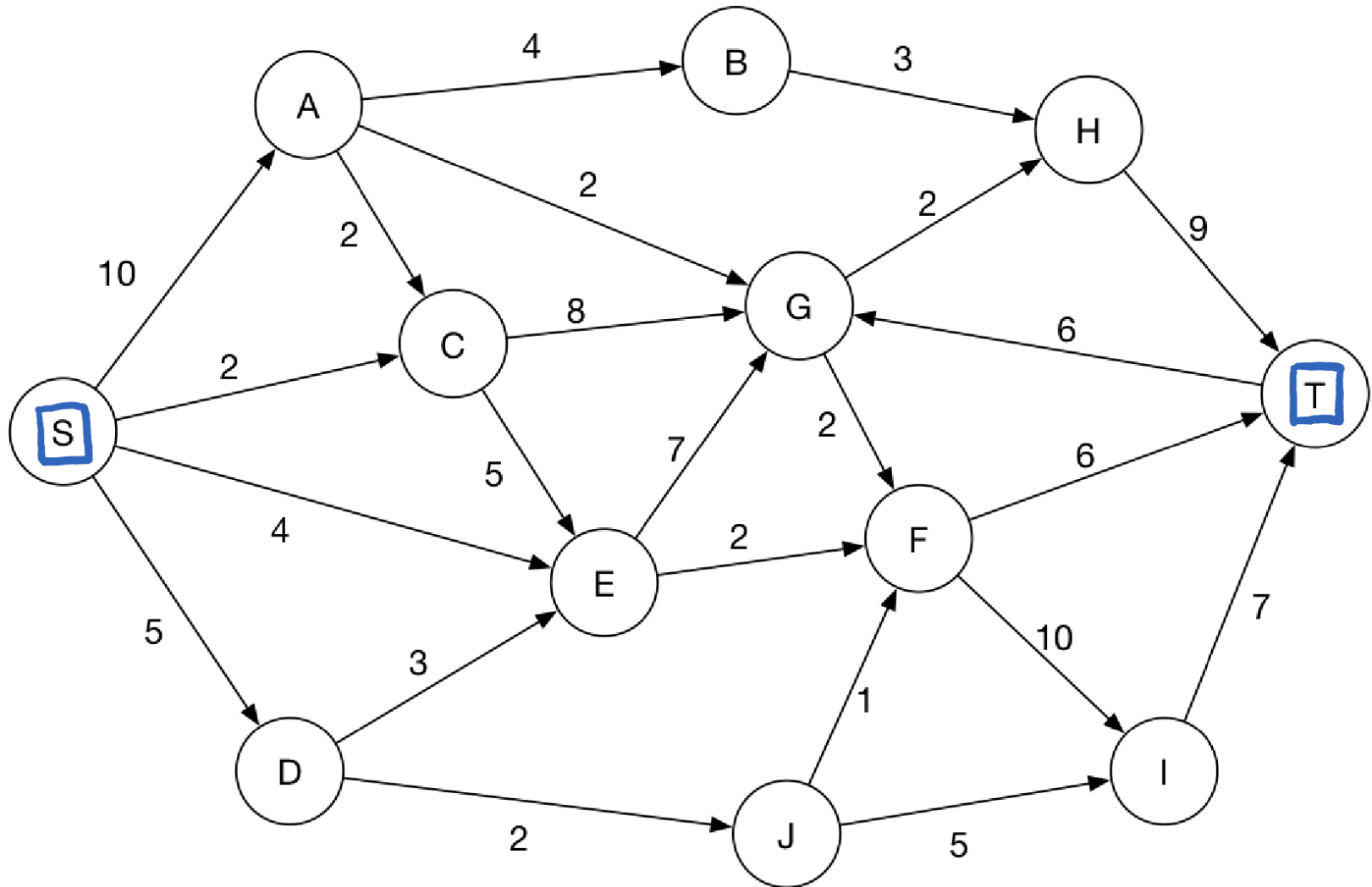

# A couple of good attempts

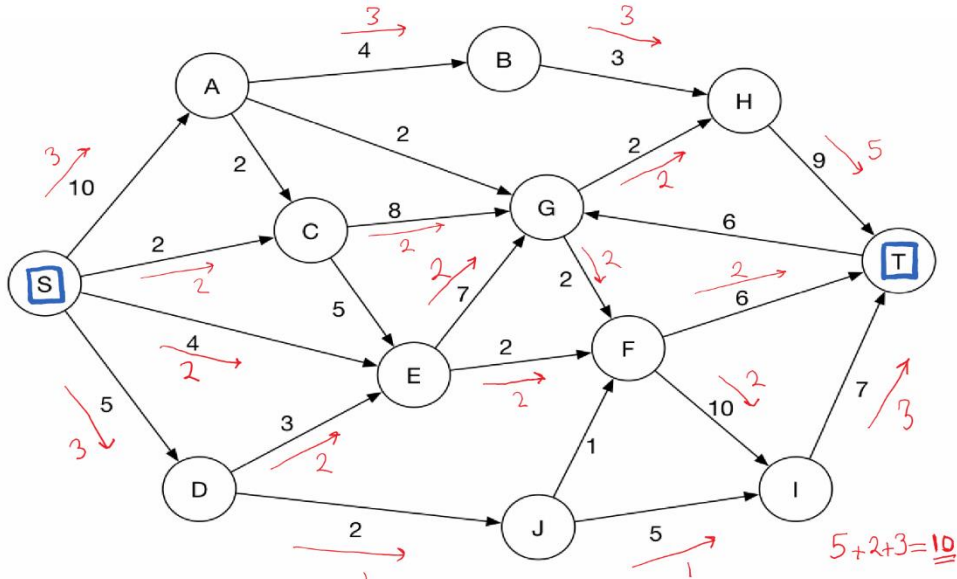

- Flow of value **10**
- Can you do better?

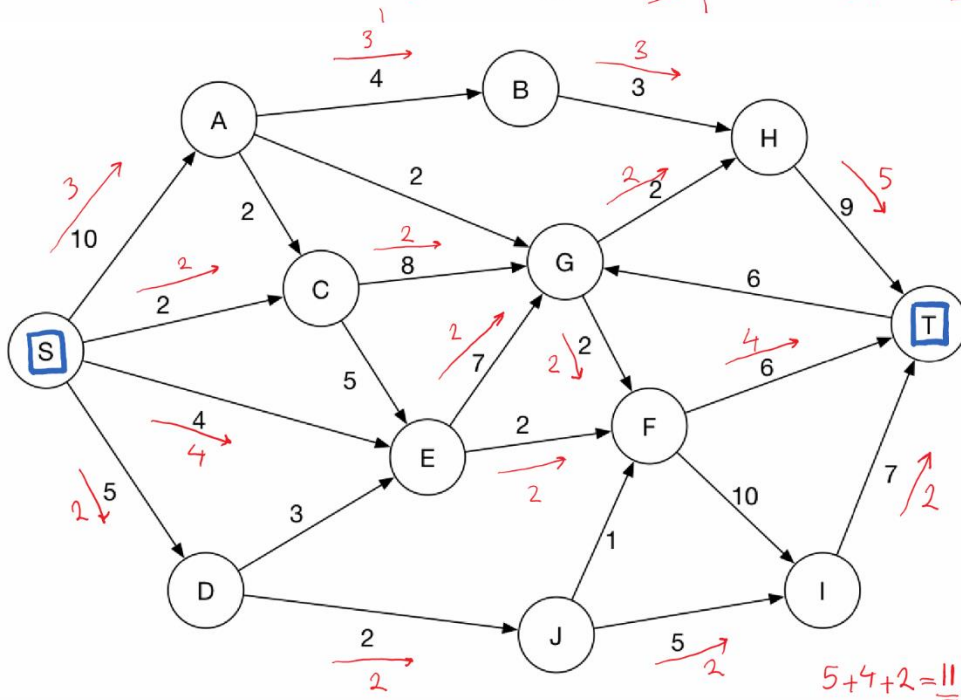

- Flow of value **11**
- Can you do better?
- How can you prove that it's impossible to do better?



# 11 is the best possible!

- Proof by magic:

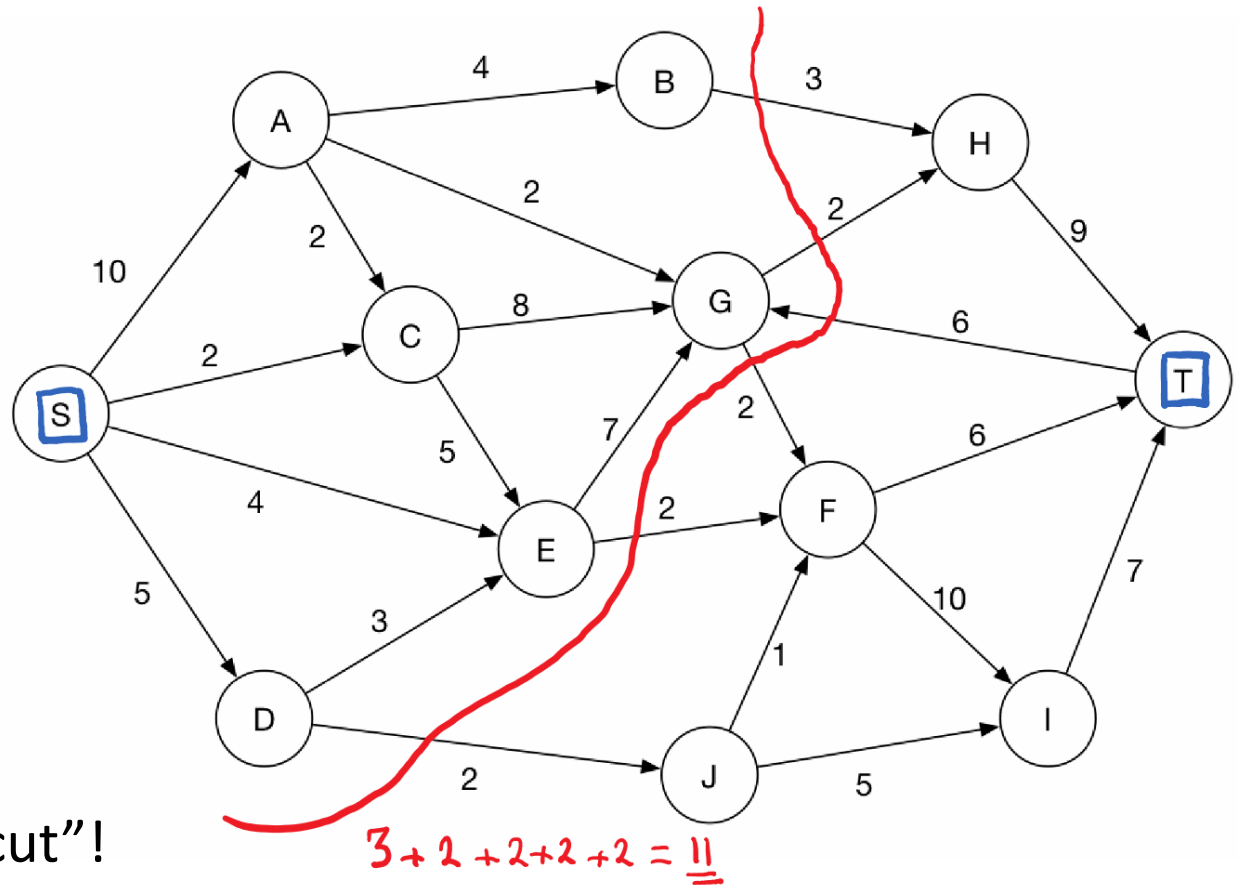

- The rabbit is the red “cut”!
- Any flow from S to T must cross the red curve.
- So it can have value at most 11.

- And here is the magic: such a proof is *always* possible! 17

# Let's try a more realistic graph

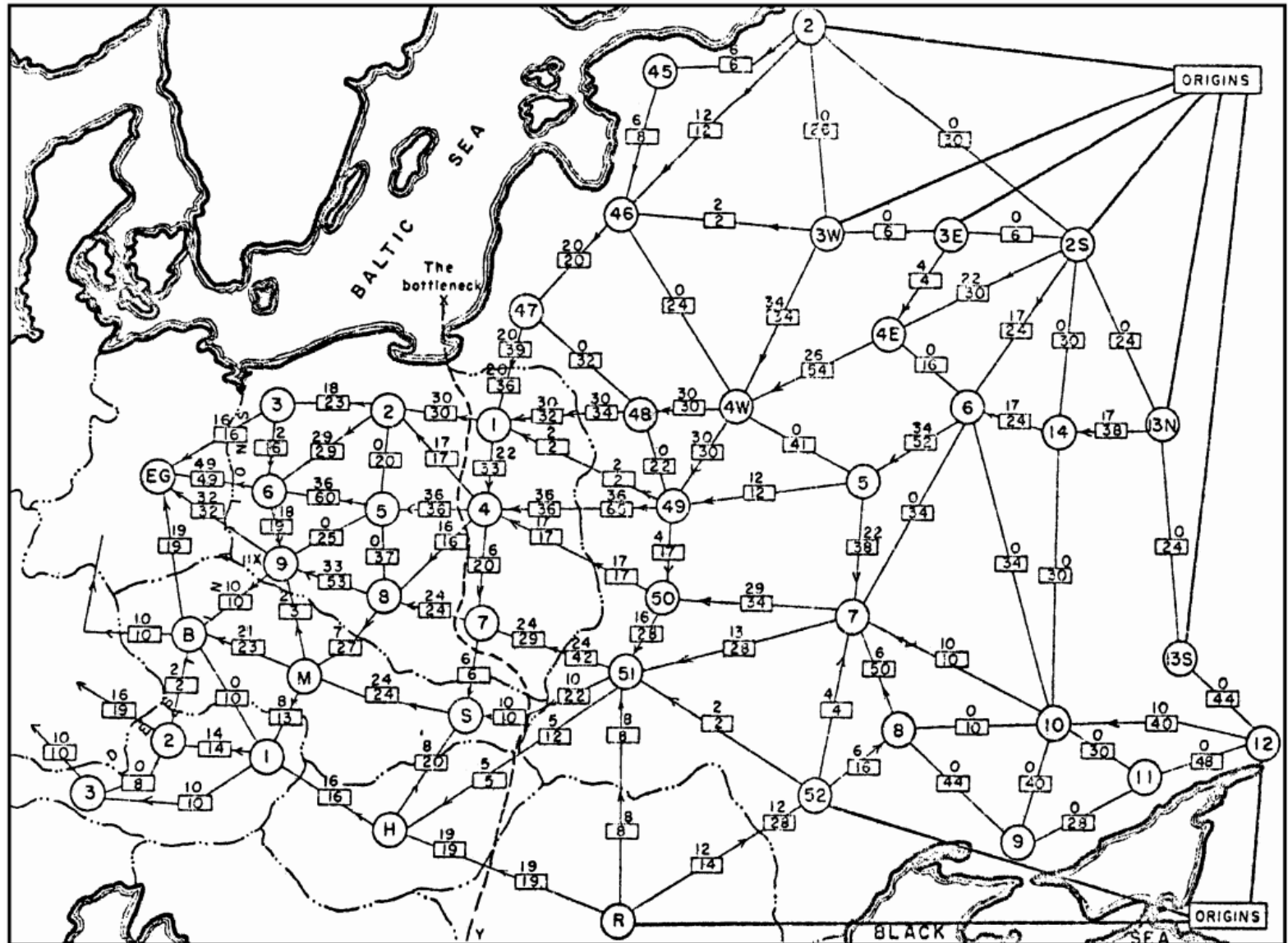

■ How long do you think an optimization solver would take (on my laptop) to find the best solution here?

■ How many lines of code do you think you have to write for it?

■ How would someone who hasn't seen optimization approach this?

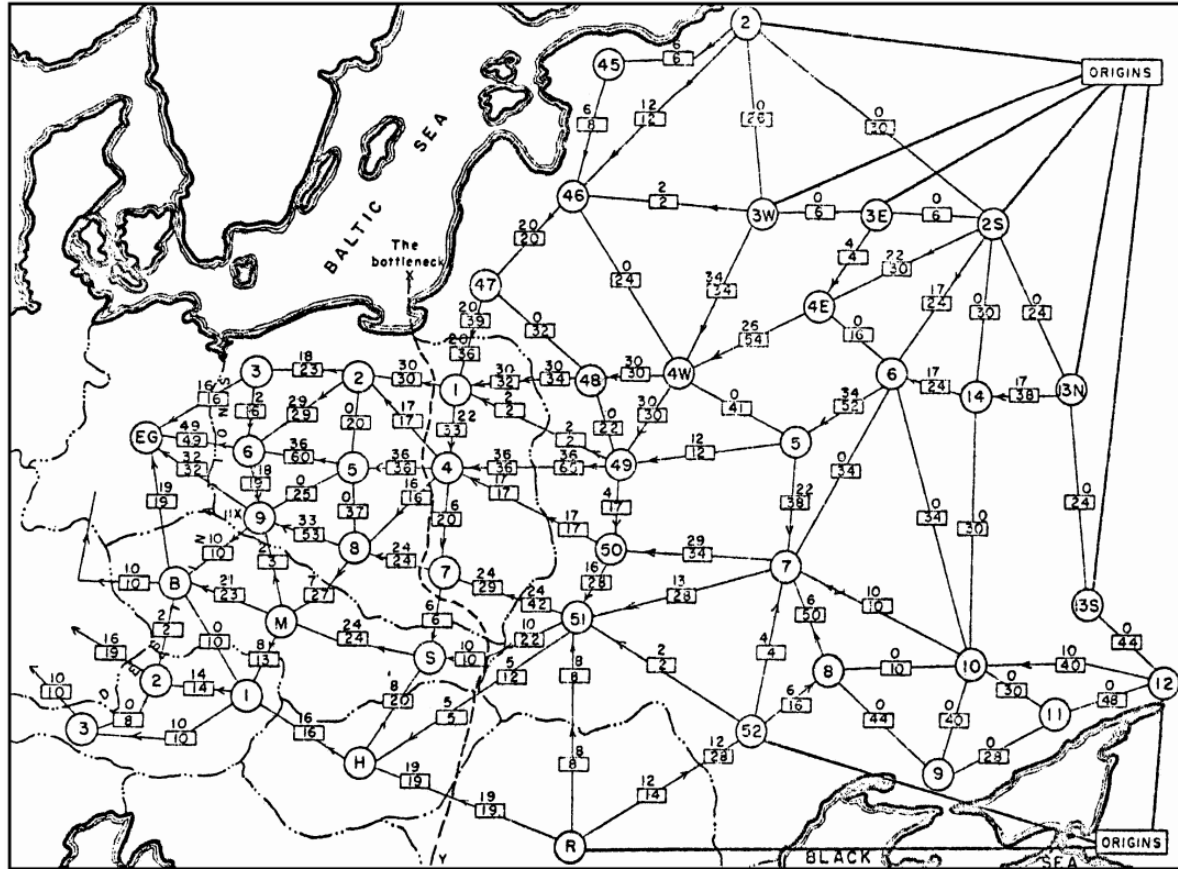

■ Trial and error?

■ Push a little flow here, a little there...

■ Do you think they are likely to find the best solution?

# A bit of history behind this map

- From a secret report by Harris and Ross (1955) written for the Air Force.
- Railway network of the Western Soviet Union going to Eastern Europe.
- Declassified in 1999.
- Look at the min-cut on the map (called the “bottleneck”)!
- There are 44 vertices, 105 edges, and the max flow is 163K.

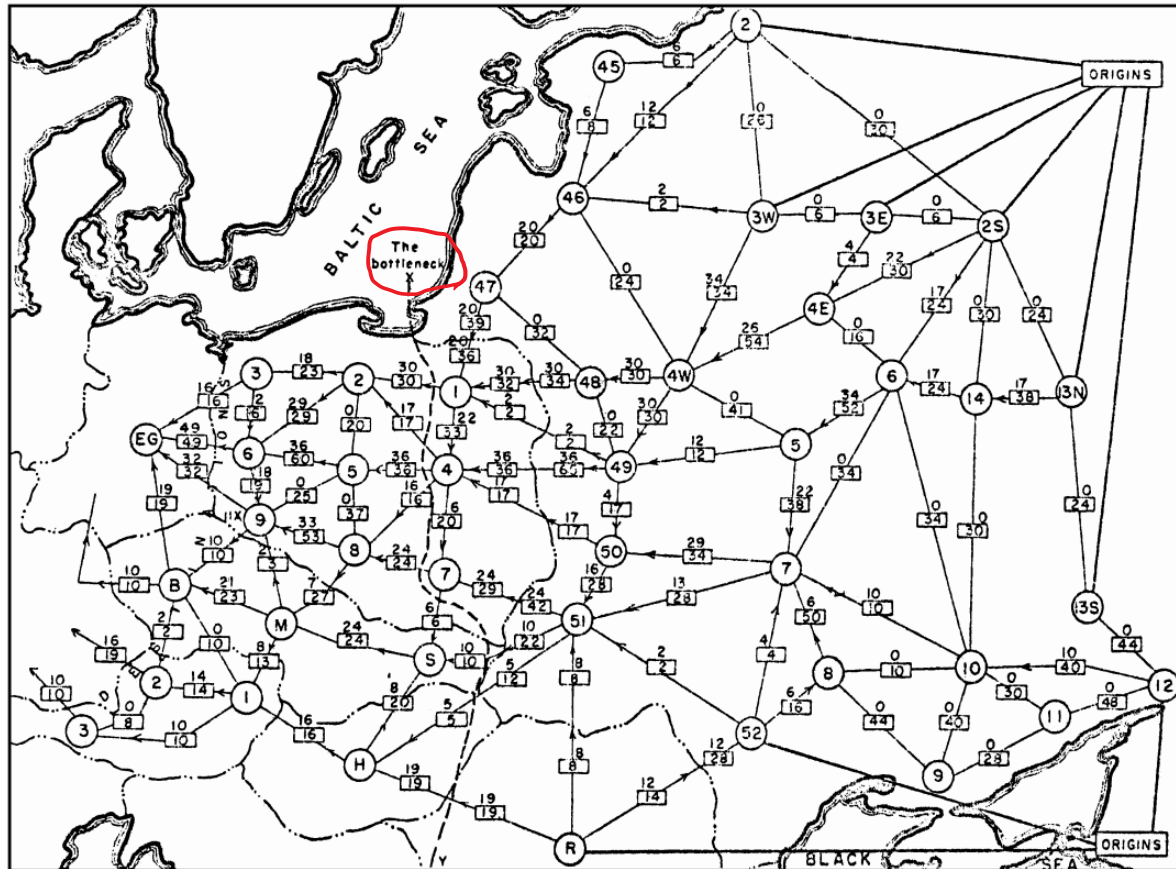

- Harris and Ross gave a heuristic which happened to solve the problem optimally in this case.
- Later that year (1955), the famous Ford-Fulkerson algorithm came out of the RAND corporation. The algorithm always finds the best solution (for rational edge costs).

Let's look at a second problem

...and tell me which one you  
thought was easier

# Two finals in one day? No thanks.

- The department chair at ORFE would like to schedule the final exams for 12 graduate courses offered this semester.
- He wants to have as many exams as possible on the same day, so everyone gets done quickly and goes on vacation.
- There is just one constraint:  
No student should have  $>1$  exam on that day.

- The nodes of this graph are the 12 courses.
- There is an edge between two nodes if and only if there is at least one student who is taking both courses.
- If we want to schedule as many exams as possible on the same day, what are we looking for in this graph?

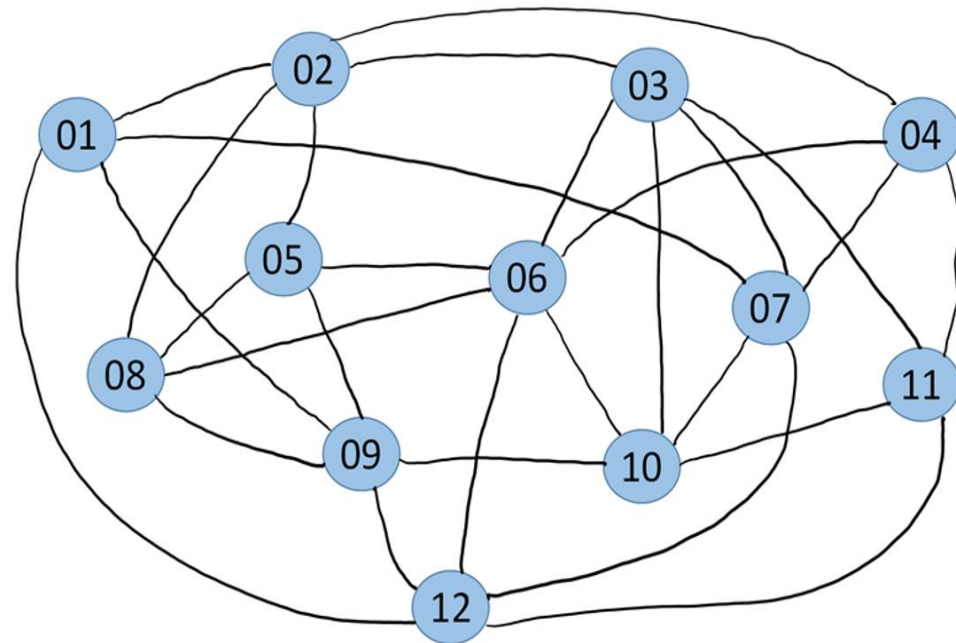

- The largest collection of nodes such that no two nodes share an edge.

Let me start things off for you. Here is 3 concurrent final exams:

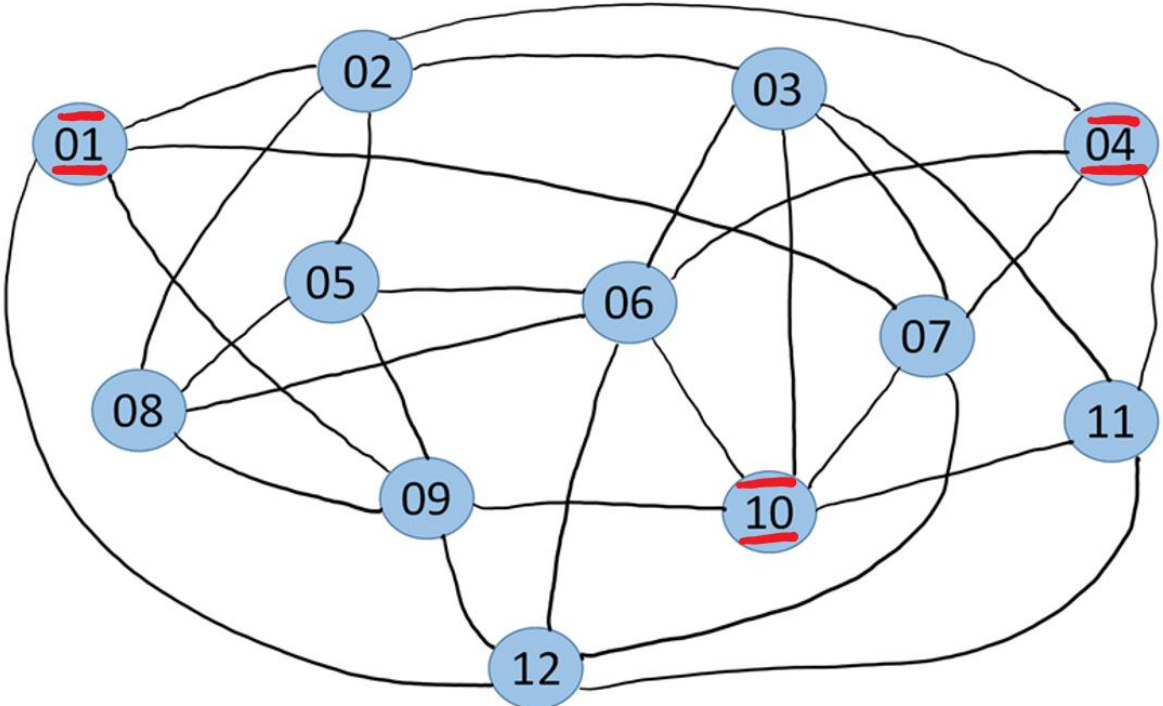

- Can you do better?
- How much better?
- You all get a copy of this graph.

You have 6 minutes!

# You tell me, I draw...

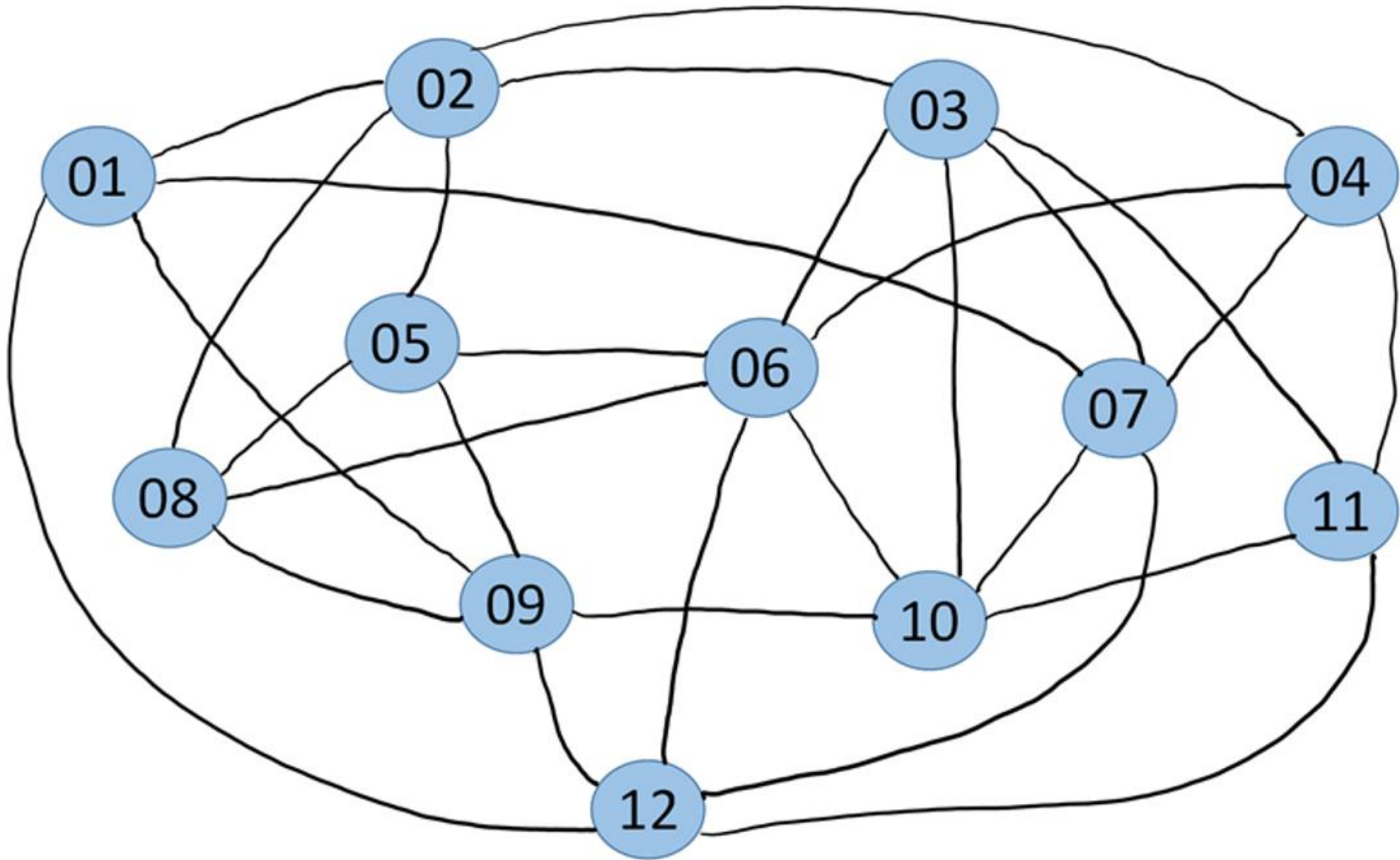



# A couple of good attempts

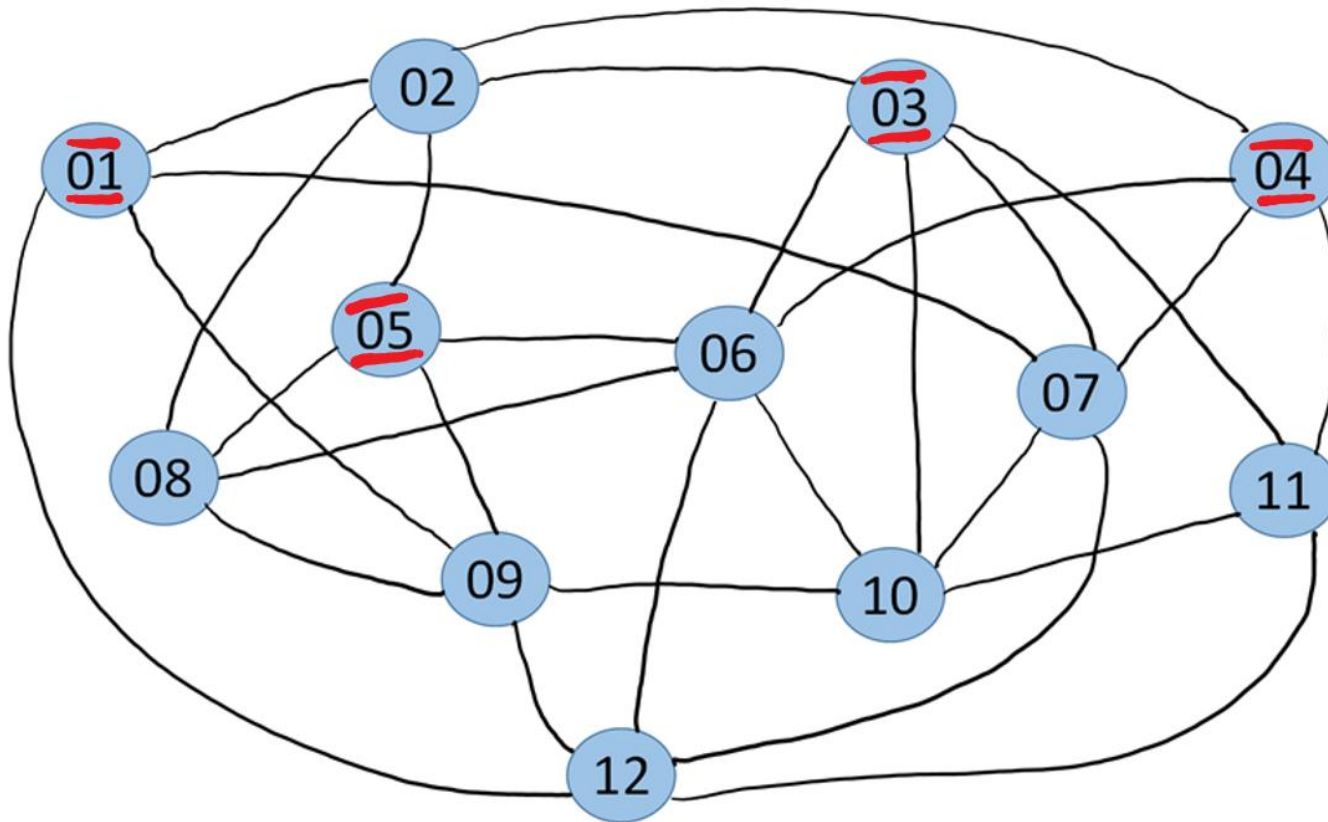

4 exams

▪ Can you do better?

# A couple of good attempts

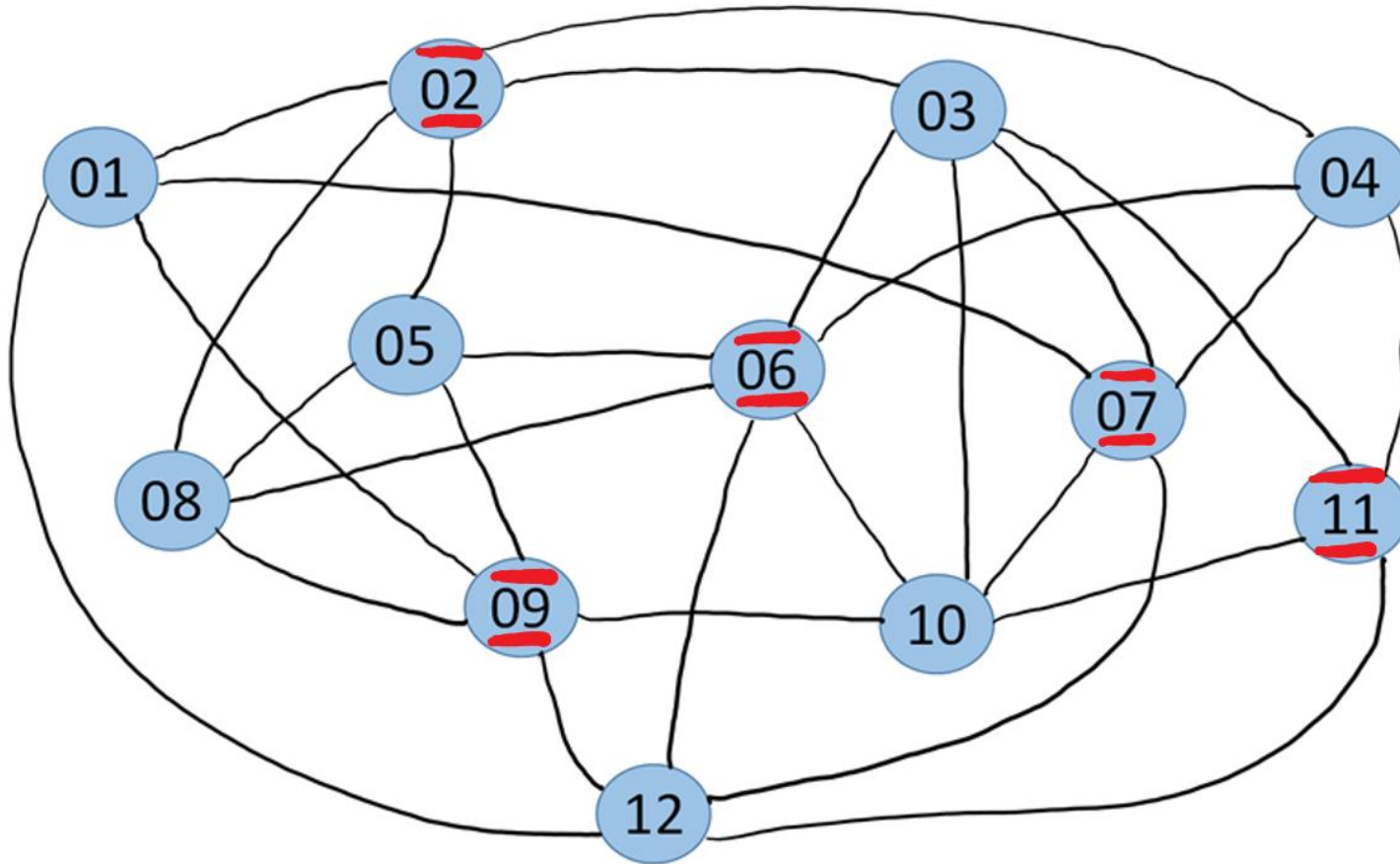

5 exams

▪ Can you do better?

# A couple of good attempts

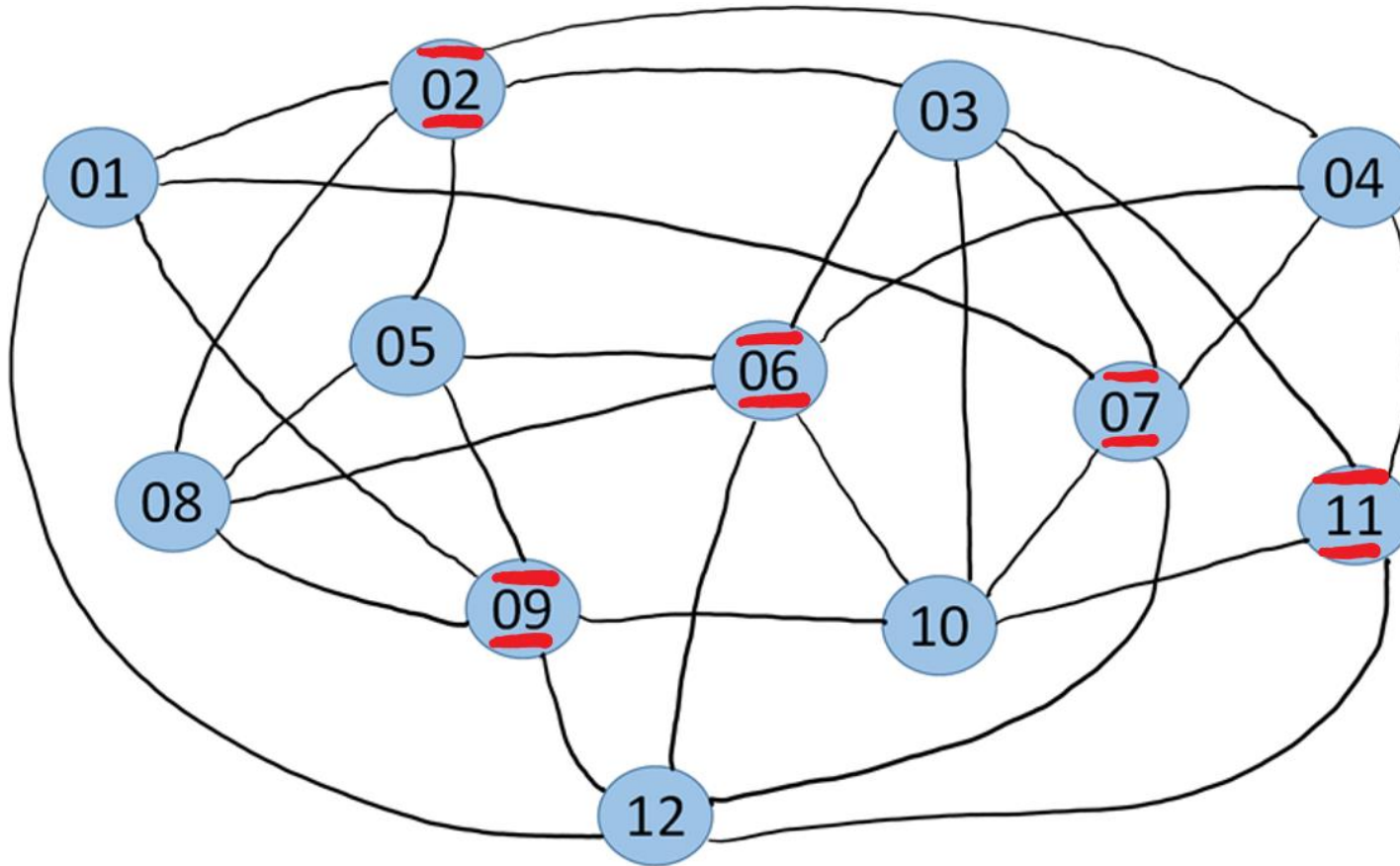

5 exams

- Tired of trying?
- Is this the best possible?

# 5 is the best possible!

- Proof by magic?



- Unfortunately not ☹️

- No magician in the world has pulled out such a rabbit to this day! (By this we mean a trick that would work on *all* graphs.)

- Of course there is always a proof:

- Try all possible subsets of 6 nodes.

- There are **924** of them.

- Observe that none of them work.

- But this is no magic. It impresses nobody. We want a “short” proof. (We will formalize what this means.) Like the one in our max-flow example.

- Let’s appreciate this further...

# Let's try another graph

▪ Encouraged by the success of ORFE, now the Dean of Engineering wants to do the same for 115 SEAS courses.

▪ How many final exams on the same day are possible? Can you do 17?

▪ You have 6 minutes! ;)

▪ Want to try out all possibilities for 17 exams?

▪ There are over 80000000000000000000 of them!

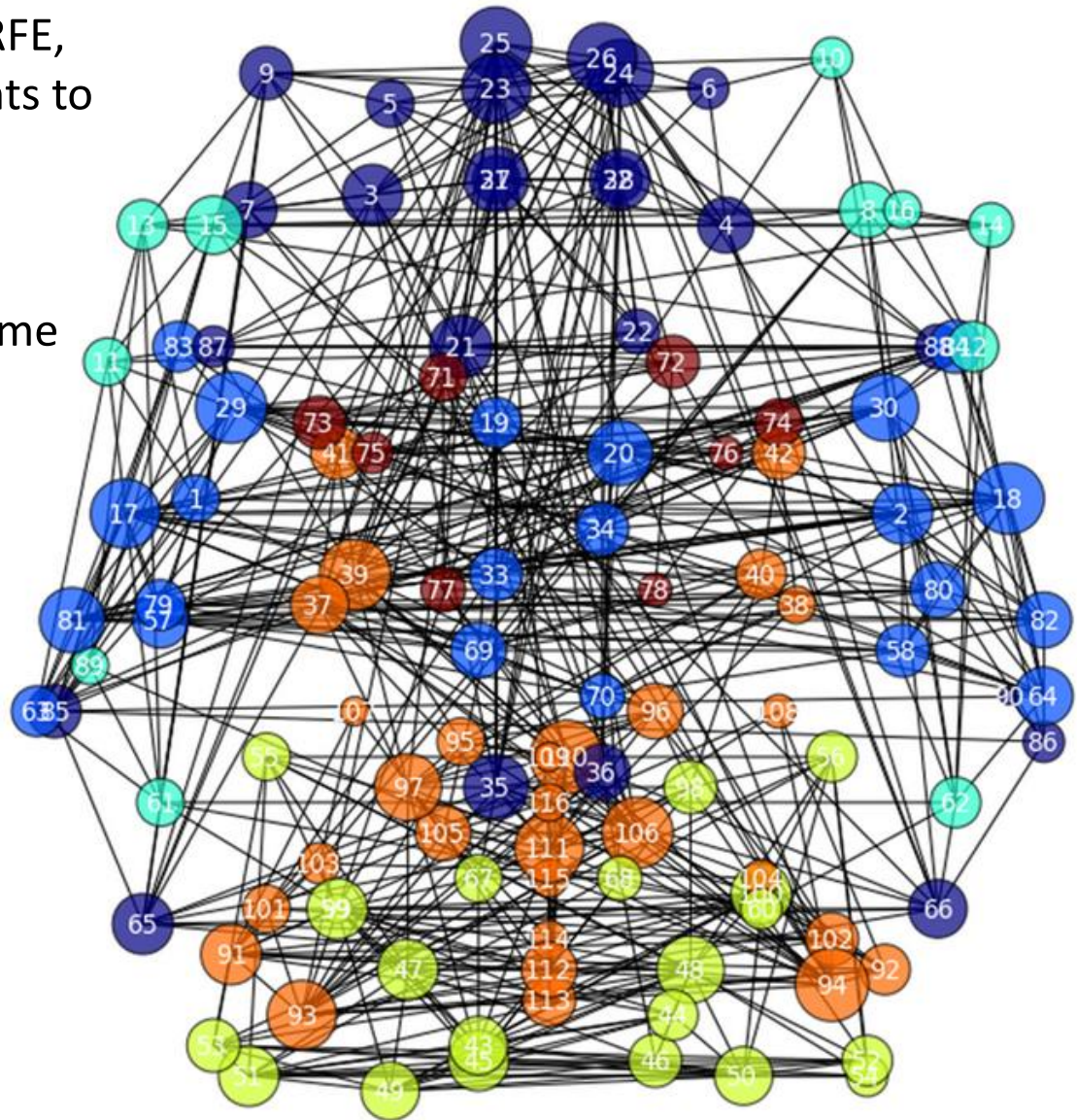

# But there is some good news

- Even though finding the best solution always may be too much to hope for, techniques from optimization (and in particular from the area of *convex optimization*) often allow us to find high-quality solutions with performance guarantees.

- For example, an optimization algorithm may quickly find 16 concurrent exams for you.

- You really want to know if 17 is impossible. Instead, another optimization algorithm (or sometimes the same one) tells you that 19 is impossible.

- This is very useful information! You know you got 16, and no one can do better than 19.

- We will see a lot of convex optimization in this class!

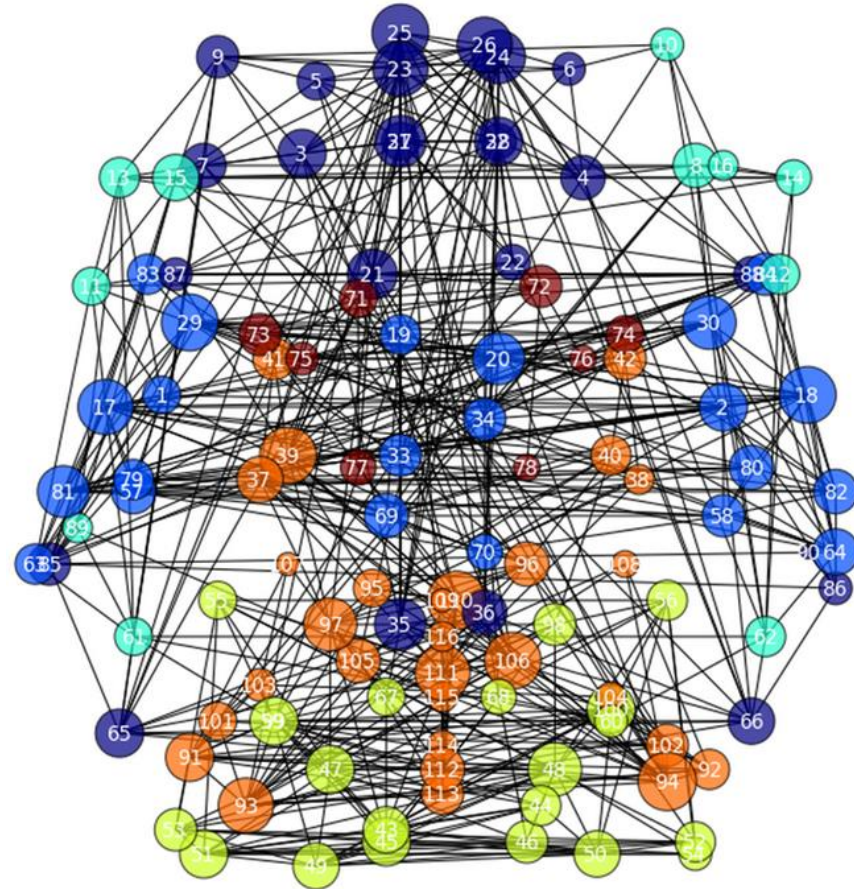

# Which of the two problems was harder for you?

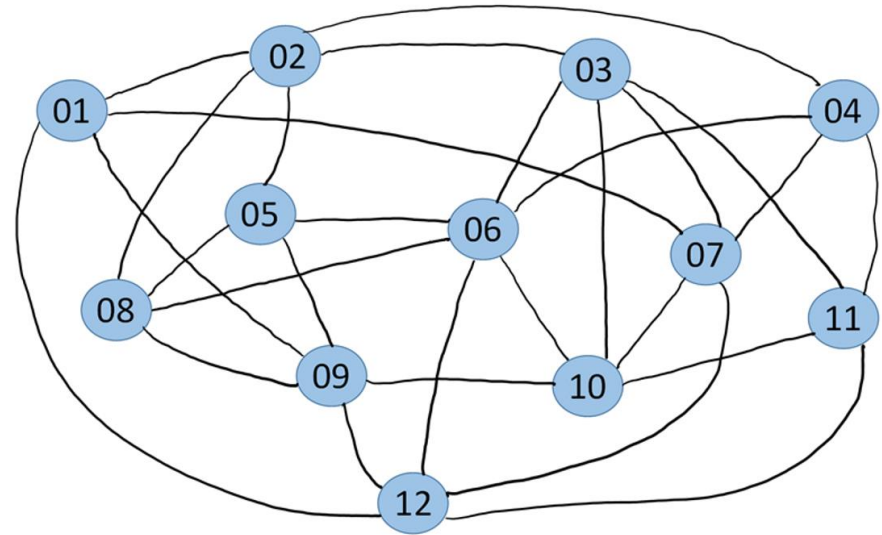
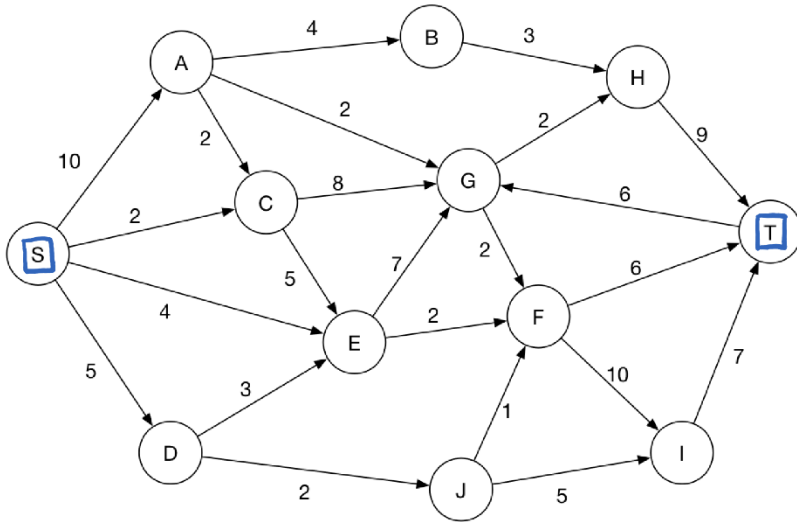

- Not always obvious. A lot of research in optimization and computer science goes into distinguishing the “tractable” problems from the “intractable” ones.
- The two brain teasers actually just gave you a taste of the **P vs. NP** problem. (If you have not heard about this, that’s OK. You will soon.)
- The first problem we can solve efficiently (in “polynomial time”).
- The second problem: no one knows. If you do, you literally get \$1M!
  - More importantly, your algorithm immediately translates to an efficient algorithm for thousands of other problems no one knows how to solve.



# Modelling problems as a mathematical program



# Let's revisit our first game

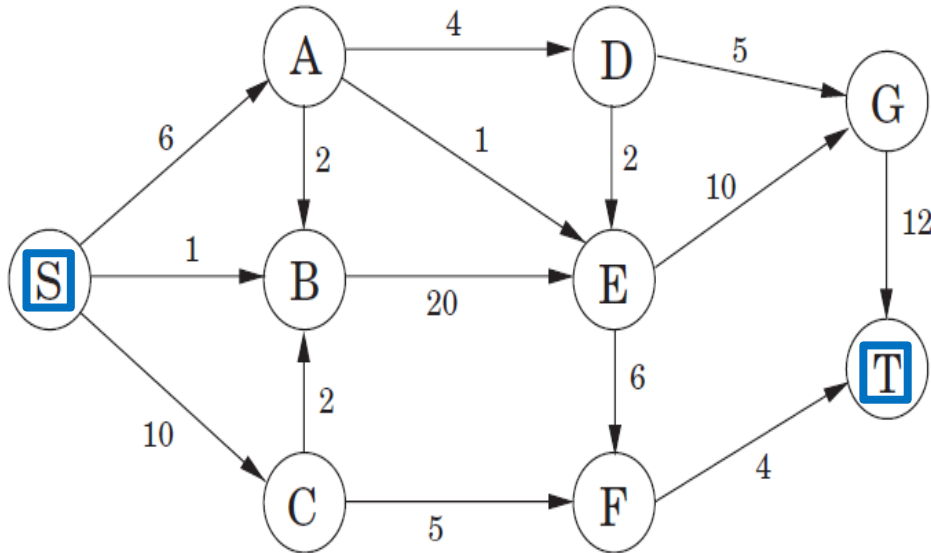

- What were your decision variables?
- What were your constraints?
- What was your objective function?

## ▪ Rules of the game:

- Cannot exceed capacity on the edges.
- For each node, except for S and T, flow in = flow out (i.e., no storage).
- **Goal:** ship as much oil as you can from S to T.

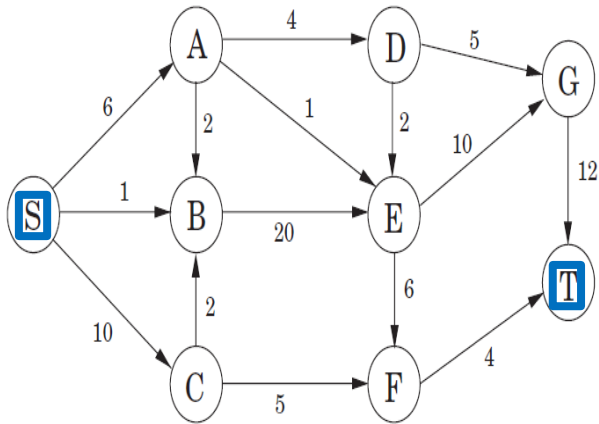

$x_{SA}, x_{AD}, x_{BE}, \dots, x_{GT}$  ← Decision variables

max.  $x_{SA} + x_{SB} + x_{SC}$  ← Objective function

s.t.

- o  $x_{SA}, x_{AD}, x_{BE}, \dots, x_{GT} \geq 0$
  - o  $x_{SA} \leq 6, x_{AB} \leq 2, x_{EG} \leq 10, \dots, x_{GT} \leq 12$
  - o  $\left\{ \begin{array}{l} x_{SA} = x_{AD} + x_{AB} + x_{AE} \\ x_{SC} = x_{CB} + x_{CF} \\ \vdots \\ x_{CF} + x_{EF} = x_{FT} \end{array} \right.$
- ← Constraints

# Let's revisit our second game

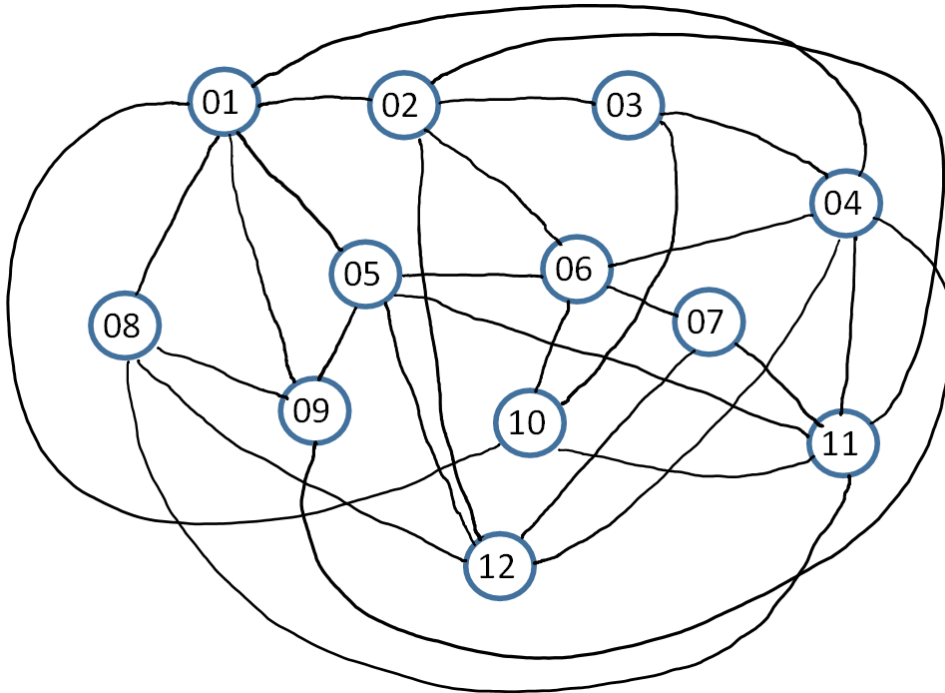

- What were your decision variables?
- What were your constraints?
- What was your objective function?

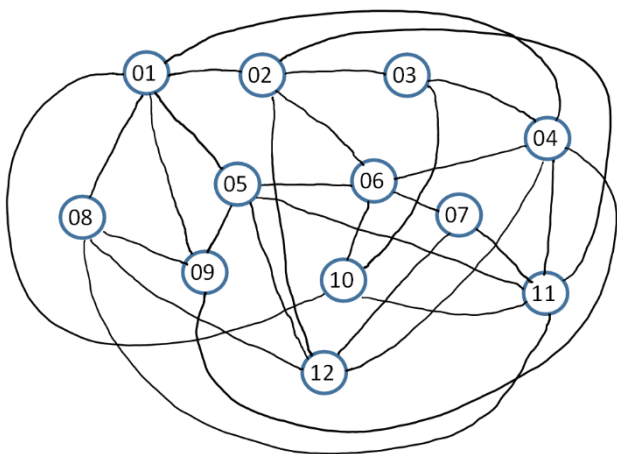

$x_1, x_2, \dots, x_{12}$  ← Decision variables

max.  $x_1 + x_2 + \dots + x_{12}$  ← Objective function

s.t.

o  $x_i (1 - x_i) = 0, i = 1, \dots, 12$

o  $\left[ \begin{array}{l} x_1 + x_2 \leq 1 \\ x_1 + x_8 \leq 1 \\ x_4 + x_6 \leq 1 \\ \vdots \\ x_{12} + x_8 \leq 1 \end{array} \right. \quad \text{(one per edge)}$

← Constraints

# Why one hard and one easy? How can you tell?

$$x_{SA}, x_{AD}, x_{BE}, \dots, x_{GT}$$

$$\max. \quad x_{SA} + x_{SB} + x_{SC}$$

s.t.

$$\circ \quad x_{SA}, x_{AD}, x_{BE}, \dots, x_{GT} \geq 0$$

$$\circ \quad x_{SA} \leq 6, x_{AB} \leq 2, x_{EG} \leq 10, \dots, x_{GT} \leq 12$$

$$\circ \quad \begin{cases} x_{SA} = x_{AD} + x_{AB} + x_{AE} \\ x_{SC} = x_{CB} + x_{CF} \\ \vdots \\ x_{CF} + x_{EF} = x_{FT} \end{cases}$$

$$x_1, x_2, \dots, x_{12}$$

$$\max. \quad x_1 + x_2 + \dots + x_{12}$$

s.t.

$$\circ \quad x_i (1 - x_i) = 0, \quad i = 1, \dots, 12$$

$$\circ \quad \begin{cases} x_1 + x_2 \leq 1 \\ x_1 + x_8 \leq 1 \\ x_4 + x_6 \leq 1 \\ \vdots \\ x_{12} + x_8 \leq 1 \end{cases} \quad (\text{one per edge})$$

▪ **Caution:** just because we can write something as a mathematical program, it doesn't mean we can solve it.

# Fermat's Last Theorem

- Can you give me three positive integers  $x, y, z$  such that

$$x^2 + y^2 = z^2?$$

- Sure: 

(3, 4, 5)	(5, 12, 13)	(8, 15, 17)	(7, 24, 25)
(20, 21, 29)	(12, 35, 37)	(9, 40, 41)	(28, 45, 53)

And there are infinitely many more...

- How about  $x^3 + y^3 = z^3?$

- How about  $x^4 + y^4 = z^4?$

- How about  $x^5 + y^5 = z^5?$



# Fermat's Last Theorem

## ■ Fermat's conjecture (1637):

For  $n \geq 3$ , the equation  $x^n + y^n = z^n$  has no solution over positive integers.

■ Consider the following optimization problem (mathematical program):

$$\min_{x, y, z, n} (x^n + y^n - z^n)^2$$

$$\text{s.t. } x \geq 1, y \geq 1, z \geq 1, n \geq 3,$$

$$\sin^2 \pi n + \sin^2 \pi x + \sin^2 \pi y + \sin^2 \pi z = 0.$$

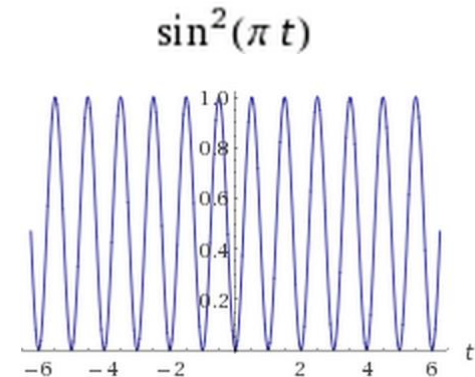

■ Innocent-looking optimization problem: 4 variables, 5 constraints.

■ If you could show the optimal value is non-zero, you would prove Fermat's conjecture!



# Course objectives

- The skills I hope you acquire:
  - Ability to view your own field through the lens of optimization and computation
    - To help you, we'll draw applications from operations research, statistics, finance, machine learning, engineering, ...
  - Learn about several topics in scientific computing
  - More mathematical maturity and ability for rigorous reasoning
    - There will be some proofs in lecture. Easier ones on homework.
  - Enhance your coding abilities (nothing too fancy, simple MATLAB)
    - There will be a coding component on every homework and on the take-home final.
    - You are free to use any other programming language instead (e.g., Python)
  - Ability to recognize hard and easy optimization problems
  - Ability to use optimization software
    - Understand the algorithms behind the software for some easier subclass of problems.

# Software you need to download

- Right away:

MATLAB

Available for free to Princeton students

You are free to use any other programming language instead (e.g., Python). The solutions that we provide will be in MATLAB (though, I am asking the AIs to add Python solutions).

- In the next week or two (will appear on HW#2 or #3):

CVX

<http://cvxr.com/cvx/>

(If you are comfortable with Python, you are free to use CVXPY instead:

<https://www.cvxpy.org/>)

# Course logistics

- See syllabus.

- Course website:

<http://aaa.princeton.edu/orf363>

- For those interested:

- Princeton Optimization Seminar
- <http://orfe.princeton.edu/events>

- Image credits and references:

- [DPV08] S. Dasgupta, C. Papadimitriou, and U. Vazirani. Algorithms. McGraw Hill, 2008.
- [Sch05] A. Schrijver. On the history of combinatorial optimization (till 1960). In “Handbook of Discrete Optimization”, Elsevier, 2005. <http://homepages.cwi.nl/~lex/files/histco.pdf>