

μA7800 SERIES POSITIVE-VOLTAGE REGULATORS

SLVS056B – MAY 1976 – REVISED OCTOBER 1996

- 3-Terminal Regulators
- Output Current Up to 1.5 A
- Internal Thermal Overload Protection
- High Power Dissipation Capability
- Internal Short-Circuit Current Limiting
- Output Transistor Safe-Area Compensation
- Direct Replacements for Fairchild μA7800 Series

description

This series of fixed-voltage monolithic integrated-circuit voltage regulators is designed for a wide range of applications. These applications include on-card regulation for elimination of noise and distribution problems associated with single-point regulation. Each of these regulators can deliver up to 1.5 A of output current. The internal current limiting and thermal shutdown features of these regulators make them essentially immune to overload. In addition to use as fixed-voltage regulators, these devices can be used with external components to obtain adjustable output voltages and currents and also used as the power-pass element in precision regulators.

The μA7800C series is characterized for operation over the virtual junction temperature range of 0°C to 125°C. The μA7805Q and μA7812Q are characterized for operation over the virtual junction temperature range of -40°C to 125°C.

KC PACKAGE
(TOP VIEW)

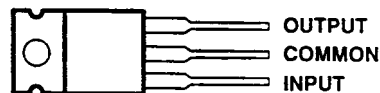

The common terminal is in electrical contact with the mounting base.

TO-220AB

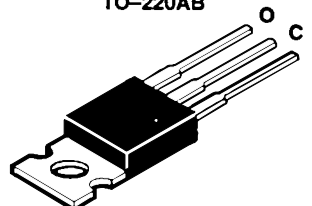

KTE PACKAGE
(TOP VIEW)

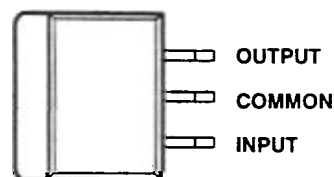

The common terminal is in electrical contact with the mounting base.

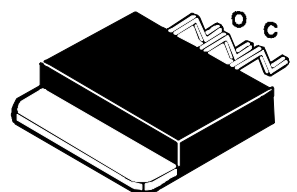

AVAILABLE OPTIONS

T _J	V _{O(nom)} (V)	PACKAGED DEVICES		CHIP FORM (Y)
		PLASTIC FLANGE-MOUNT (KC)	HEAT-SINK MOUNTED† (KTE)	
0°C to 125°C	5	μA7805CKC	μA7805CKTE	μA7805Y
	6	μA7806CKC	μA7806CKTE	μA7806Y
	8	μA7808CKC	μA7808CKTE	μA7808Y
	8.5	μA7885CKC	μA7885CKTE	μA7885Y
	10	μA7810CKC	μA7810CKTE	μA7810Y
	12	μA7812CKC	μA7812CKTE	μA7812Y
	15	μA7815CKC	μA7815CKTE	μA7815Y
	18	μA7818CKC	μA7818CKTE	μA7818Y
-40°C to 125°C	5	μA7805QKC	μA7805QKTE	—
	12	μA7812QKC	μA7812QKTE	—

† The KTE package is also available taped and reeled.



Please be aware that an important notice concerning availability, standard warranty, and use in critical applications of Texas Instruments semiconductor products and disclaimers thereto appears at the end of this data sheet.

PRODUCTION DATA information is current as of publication date. Products conform to specifications per the terms of Texas Instruments standard warranty. Production processing does not necessarily include testing of all parameters.

**TEXAS
INSTRUMENTS**

POST OFFICE BOX 655303 • DALLAS, TEXAS 75265

Copyright © 1996, Texas Instruments Incorporated

μA7800 SERIES POSITIVE-VOLTAGE REGULATORS

SLVS056B - MAY 1976 - REVISED OCTOBER 1996

schematic

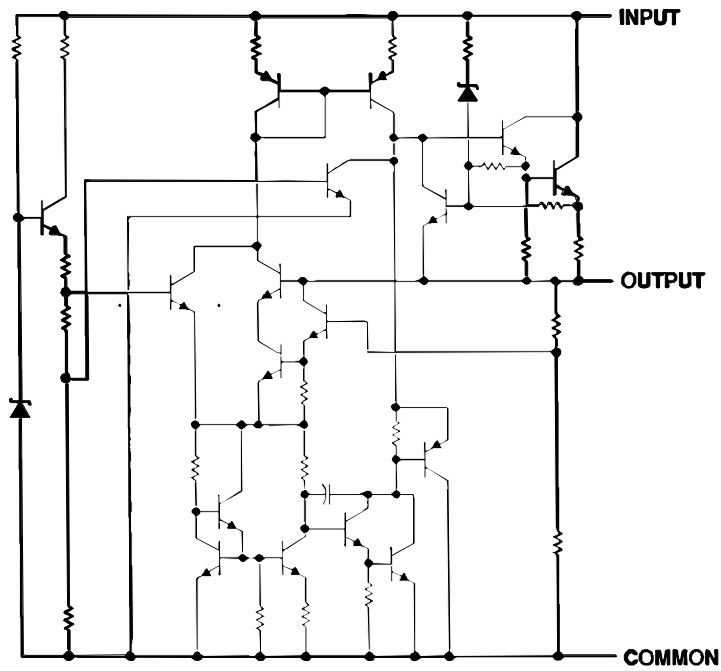

μA78xxY chip information

These chips, when properly assembled, display characteristics similar to the μA78xxC. Thermal compression or ultrasonic bonding may be used on the doped aluminum bonding pads. The chips may be mounted with conductive epoxy or a gold-silicon preform.

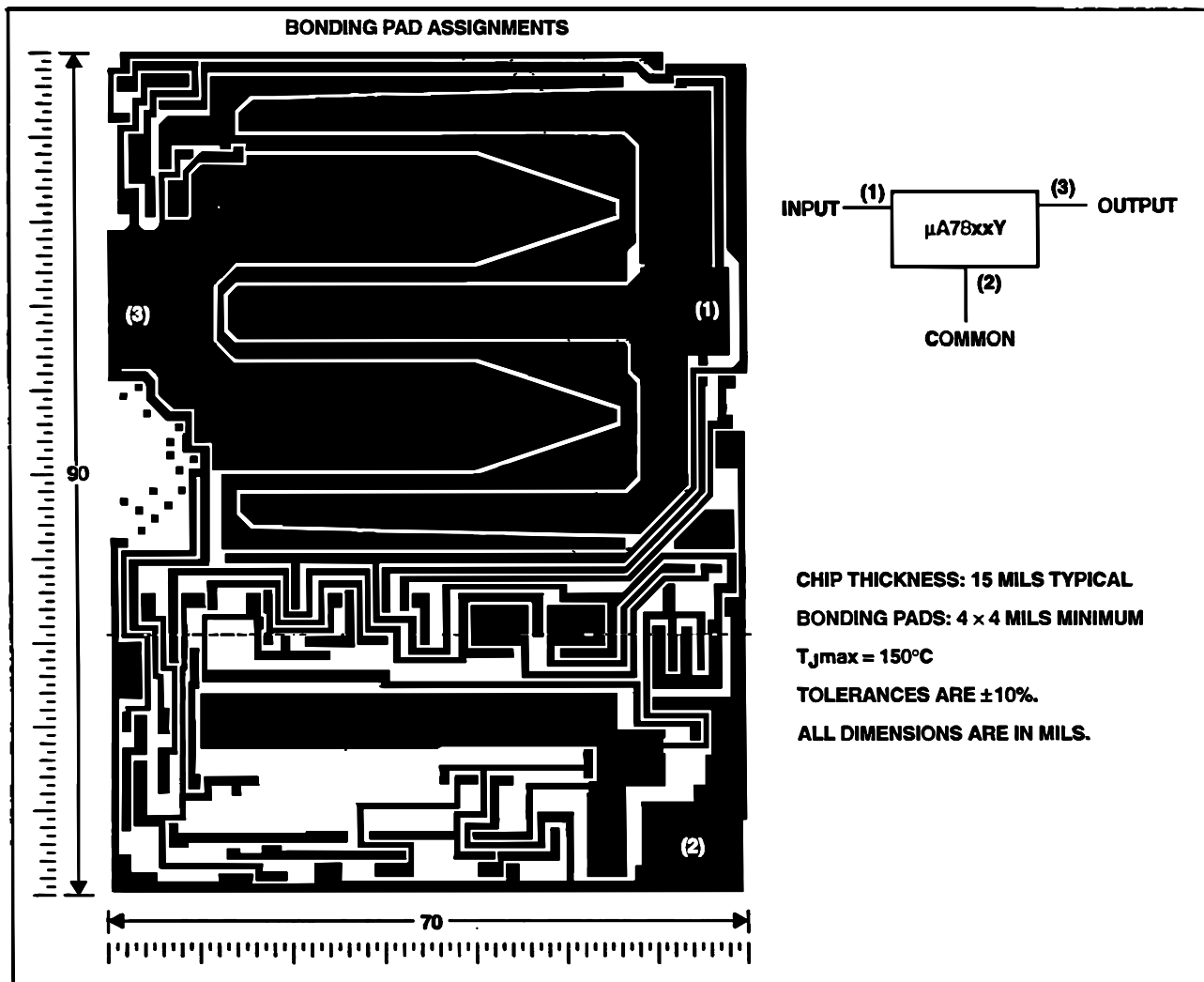

μA7800 SERIES POSITIVE-VOLTAGE REGULATORS

SLVS056B – MAY 1976 – REVISED OCTOBER 1996

absolute maximum ratings over operating temperature ranges (unless otherwise noted)†

Input voltage, V_i : μA7824C	40 V
All others	35 V
Continuous total power dissipation at (or below) $T_A = 25^\circ\text{C}$ (see Note 1)	See Dissipation Rating Tables
Continuous total power dissipation at (or below) $T_C = 90^\circ\text{C}$ (see Note 1)	See Dissipation Rating Tables
Operating free-air, T_A , case, T_C , or virtual junction, T_J , temperature range	-40 to 150°C
Storage temperature range, T_{stg}	-65 to 150°C
Lead temperature 1,6 mm (1/16 inch) from case for 10 seconds	260°C

† Stresses beyond those listed under "absolute maximum ratings" may cause permanent damage to the device. These are stress ratings only, and functional operation of the device at these or any other conditions beyond those indicated under "recommended operating conditions" is not implied. Exposure to absolute-maximum-rated conditions for extended periods may affect device reliability.

NOTE 1: For operation above 25°C free-air or 90°C case temperature, refer to Figure 1 and Figure 2. To avoid exceeding the design maximum virtual junction temperature, these ratings should not be exceeded. Due to variations in individual device electrical characteristics and thermal resistance, the built-in thermal overload protection may be activated at power levels slightly above or below the rated dissipation.

DISSIPATION RATING TABLE — FREE-AIR TEMPERATURE

PACKAGE	$T_A \leq 25^\circ\text{C}$ POWER RATING	DERATING FACTOR ABOVE $T_A = 25^\circ\text{C}$	$T_A = 70^\circ\text{C}$ POWER RATING	$T_A = 105^\circ\text{C}$ POWER RATING	$T_A = 125^\circ\text{C}$ POWER RATING
KC	2000 mW	16.0 mW/°C	1280 mW	720 mW	400 mW
KTE	1900 mW	15.2 mW/°C	1216 mW	684 mW	380 mW

DISSIPATION RATING TABLE — CASE TEMPERATURE

PACKAGE	$T_C \leq 90^\circ\text{C}$ POWER RATING	DERATING FACTOR ABOVE $T_C = 90^\circ\text{C}$	$T_A = 125^\circ\text{C}$ POWER RATING
KC	15000 mW	250.0 mW/°C	6250 mW
KTE	14300 mW	238.0 mW/°C	5970 mW

FREE-AIR TEMPERATURE
DISSIPATION DERATING CURVE

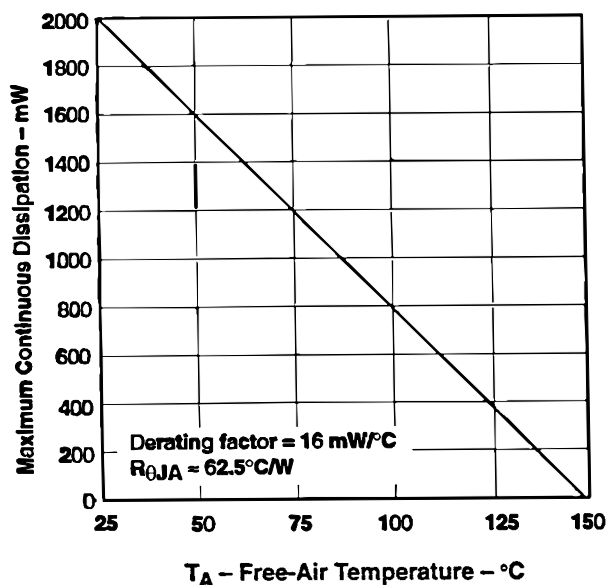

Figure 1

CASE TEMPERATURE
DISSIPATION DERATING CURVE

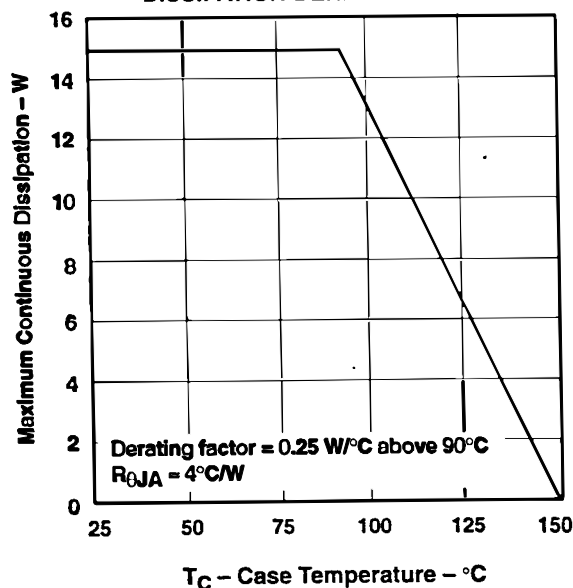

Figure 2

μA7800 SERIES POSITIVE-VOLTAGE REGULATORS

SLVS056B - MAY 1976 - REVISED OCTOBER 1996

recommended operating conditions

		MIN	MAX	UNIT
Input voltage, V_I	μA7805C	7	25	V
	μA7806C	8	25	
	μA7808C	10.5	25	
	μA7885C	10.5	25	
	μA7810C	12.5	28	
	μA7812C	14.5	30	
	μA7815C	17.5	30	
	μA7818C	21	33	
	μA7824C	27	38	
Output current, I_O			1.5	A
Operating virtual junction temperature, T_J	μA7800C Series	0	125	°C
	μA7805Q, μA7812Q	-40	125	

electrical characteristics at specified virtual junction temperature, $V_I = 10$ V, $I_O = 500$ mA (unless otherwise noted)

PARAMETER	TEST CONDITIONS	T_J †	μA7805C, μA7805Q			UNIT
			MIN	TYP	MAX	
Output voltage‡	$I_O = 5$ mA to 1 A, $V_I = 7$ V to 20 V, $P \leq 15$ W	25°C	4.8	5	5.2	V
		Full range§	4.75		5.25	
Input voltage regulation	$V_I = 7$ V to 25 V	25°C		3	100	mV
	$V_I = 8$ V to 12 V			1	50	
Ripple rejection	$V_I = 8$ V to 18 V, $f = 120$ Hz	Full range§	62	78		dB
Output voltage regulation	$I_O = 5$ mA to 1.5 A	25°C		15	100	mV
	$I_O = 250$ mA to 750 mA			5	50	
Output resistance	$f = 1$ kHz	Full range§	0.017			Ω
Temperature coefficient of output voltage	$I_O = 5$ mA	Full range§	-1.1			mV/°C
Output noise voltage	$f = 10$ Hz to 100 kHz	25°C	40			μV
Dropout voltage	$I_O = 1$ A	25°C	2			V
Bias current		25°C	4.2	8		mA
Bias current change	$V_I = 7$ V to 25 V	Full range§			1.3	mA
	$I_O = 5$ mA to 1 A				0.5	
Short-circuit output current		25°C	750			mA
Peak output current		25°C	2.2			A

† Pulse-testing techniques maintain the junction temperature as close to the ambient temperature as possible. Thermal effects must be taken into account separately. All characteristics are measured with a 0.33-μF capacitor across the input and a 0.1-μF capacitor across the output.

‡ This specification applies only for dc power dissipation permitted by absolute maximum ratings.

§ Full range virtual junction temperature is 0°C to 125°C for the μA7805C and -40°C to 125°C for the μA7805Q.

μA7800 SERIES POSITIVE-VOLTAGE REGULATORS

SLVS056B – MAY 1976 – REVISED OCTOBER 1996

electrical characteristics at specified virtual junction temperature, $V_I = 11\text{ V}$, $I_O = 500\text{ mA}$ (unless otherwise noted)

PARAMETER	TEST CONDITIONS	T_J †	μA7806C			UNIT	
			MIN	TYP	MAX		
Output voltage‡	$I_O = 5\text{ mA to }1\text{ A}$, $P \leq 15\text{ W}$, $V_I = 8\text{ V to }21\text{ V}$	25°C	5.75	6	6.25	V	
		0°C to 125°C	5.7		6.3		
Input voltage regulation	$V_I = 8\text{ V to }25\text{ V}$	25°C		5	120	mV	
	$V_I = 9\text{ V to }13\text{ V}$			1.5	60		
Ripple rejection	$V_I = 9\text{ V to }19\text{ V}$, $f = 120\text{ Hz}$	0°C to 125°C	59	75		dB	
Output voltage regulation	$I_O = 5\text{ mA to }1.5\text{ A}$	25°C		14	120	mV	
	$I_O = 250\text{ mA to }750\text{ mA}$			4	60		
Output resistance	$f = 1\text{ kHz}$	0°C to 125°C	0.019			Ω	
Temperature coefficient of output voltage	$I_O = 5\text{ mA}$	0°C to 125°C	-0.8			mV/°C	
Output noise voltage	$f = 10\text{ Hz to }100\text{ kHz}$	25°C	45			μV	
Dropout voltage	$I_O = 1\text{ A}$	25°C	2			V	
Bias current		25°C	4.3			8 mA	
Bias current change	$V_I = 8\text{ V to }25\text{ V}$	0°C to 125°C				1.3	mA
	$I_O = 5\text{ mA to }1\text{ A}$					0.5	
Short-circuit output current		25°C	550			mA	
Peak output current		25°C	2.2			A	

† Pulse-testing techniques maintain the junction temperature as close to the ambient temperature as possible. Thermal effects must be taken into account separately. All characteristics are measured with a 0.33-μF capacitor across the input and a 0.1-μF capacitor across the output.

‡ This specification applies only for dc power dissipation permitted by absolute maximum ratings.

electrical characteristics at specified virtual junction temperature, $V_I = 14\text{ V}$, $I_O = 500\text{ mA}$ (unless otherwise noted)

PARAMETER	TEST CONDITIONS	T_J †	μA7808C			UNIT	
			MIN	TYP	MAX		
Output voltage‡	$I_O = 5\text{ mA to }1\text{ A}$, $P \leq 15\text{ W}$, $V_I = 10.5\text{ V to }23\text{ V}$	25°C	7.7	8	8.3	V	
		0°C to 125°C	7.6		8.4		
Input voltage regulation	$V_I = 10.5\text{ V to }25\text{ V}$	25°C		6	160	mV	
	$V_I = 11\text{ V to }17\text{ V}$			2	80		
Ripple rejection	$V_I = 11.5\text{ V to }21.5\text{ V}$, $f = 120\text{ Hz}$	0°C to 125°C	55	72		dB	
Output voltage regulation	$I_O = 5\text{ mA to }1.5\text{ A}$	25°C		12	160	mV	
	$I_O = 250\text{ mA to }750\text{ mA}$			4	80		
Output resistance	$f = 1\text{ kHz}$	0°C to 125°C	0.016			Ω	
Temperature coefficient of output voltage	$I_O = 5\text{ mA}$	0°C to 125°C	-0.8			mV/°C	
Output noise voltage	$f = 10\text{ Hz to }100\text{ kHz}$	25°C	52			μV	
Dropout voltage	$I_O = 1\text{ A}$	25°C	2			V	
Bias current		25°C	4.3			8 mA	
Bias current change	$V_I = 10.5\text{ V to }25\text{ V}$	0°C to 125°C				1	mA
	$I_O = 5\text{ mA to }1\text{ A}$					0.5	
Short-circuit output current		25°C	450			mA	
Peak output current		25°C	2.2			A	

† Pulse-testing techniques maintain the junction temperature as close to the ambient temperature as possible. Thermal effects must be taken into account separately. All characteristics are measured with a 0.33-μF capacitor across the input and a 0.1-μF capacitor across the output.

‡ This specification applies only for dc power dissipation permitted by absolute maximum ratings.



POST OFFICE BOX 655303 • DALLAS, TEXAS 75265

μA7800 SERIES POSITIVE-VOLTAGE REGULATORS

SLVS056B – MAY 1976 – REVISED OCTOBER 1996

electrical characteristics at specified virtual junction temperature, $V_I = 15\text{ V}$, $I_O = 500\text{ mA}$ (unless otherwise noted)

PARAMETER	TEST CONDITIONS	T_J †	μA7885C			UNIT
			MIN	TYP	MAX	
Output voltage‡	$I_O = 5\text{ mA to }1\text{ A}$, $V_I = 11\text{ V to }23.5\text{ V}$, $P \leq 15\text{ W}$	25°C	8.15	8.5	8.85	V
		0°C to 125°C	8.1		8.9	
Input voltage regulation	$V_I = 10.5\text{ V to }25\text{ V}$	25°C		6	170	mV
	$V_I = 11\text{ V to }17\text{ V}$			2	85	
Ripple rejection	$V_I = 11.5\text{ V to }21.5\text{ V}$, $f = 120\text{ Hz}$	0°C to 125°C	54	70		dB
Output voltage regulation	$I_O = 5\text{ mA to }1.5\text{ A}$	25°C		12	170	mV
	$I_O = 250\text{ mA to }750\text{ mA}$			4	85	
Output resistance	$f = 1\text{ kHz}$	0°C to 125°C		0.016		Ω
Temperature coefficient of output voltage	$I_O = 5\text{ mA}$	0°C to 125°C		-0.8		mV/°C
Output noise voltage	$f = 10\text{ Hz to }100\text{ kHz}$	25°C		55		μV
Dropout voltage	$I_O = 1\text{ A}$	25°C		2		V
Bias current		25°C		4.3	8	mA
Bias current change	$V_I = 10.5\text{ V to }25\text{ V}$	0°C to 125°C			1	mA
	$I_O = 5\text{ mA to }1\text{ A}$				0.5	
Short-circuit output current		25°C		450		mA
Peak output current		25°C		2.2		A

† Pulse-testing techniques maintain the junction temperature as close to the ambient temperature as possible. Thermal effects must be taken into account separately. All characteristics are measured with a 0.33-μF capacitor across the input and a 0.1-μF capacitor across the output.

‡ This specification applies only for dc power dissipation permitted by absolute maximum ratings.

electrical characteristics at specified virtual junction temperature, $V_I = 17\text{ V}$, $I_O = 500\text{ mA}$ (unless otherwise noted)

PARAMETER	TEST CONDITIONS	T_J †	μA7810C			UNIT
			MIN	TYP	MAX	
Output voltage‡	$I_O = 5\text{ mA to }1\text{ A}$, $V_I = 12.5\text{ V to }25\text{ V}$, $P \leq 15\text{ W}$	25°C	9.6	10	10.4	V
		0°C to 125°C	9.5	10	10.5	
Input voltage regulation	$V_I = 12.5\text{ V to }28\text{ V}$	25°C		7	200	mV
	$V_I = 14\text{ V to }20\text{ V}$			2	100	
Ripple rejection	$V_I = 13\text{ V to }23\text{ V}$, $f = 120\text{ Hz}$	0°C to 125°C	55	71		dB
Output voltage regulation	$I_O = 5\text{ mA to }1.5\text{ A}$	25°C		12	200	mV
	$I_O = 250\text{ mA to }750\text{ mA}$			4	100	
Output resistance	$f = 1\text{ kHz}$	0°C to 125°C		0.018		Ω
Temperature coefficient of output voltage	$I_O = 5\text{ mA}$	0°C to 125°C		-1		mV/°C
Output noise voltage	$f = 10\text{ Hz to }100\text{ kHz}$	25°C		70		μV
Dropout voltage	$I_O = 1\text{ A}$	25°C		2		V
Bias current		25°C		4.3	8	mA
Bias current change	$V_I = 12.5\text{ V to }28\text{ V}$	0°C to 125°C			1	mA
	$I_O = 5\text{ mA to }1\text{ A}$				0.5	
Short-circuit output current		25°C		400		mA
Peak output current		25°C		2.2		A

† Pulse-testing techniques maintain the junction temperature as close to the ambient temperature as possible. Thermal effects must be taken into account separately. All characteristics are measured with a 0.33-μF capacitor across the input and a 0.1-μF capacitor across the output.

‡ This specification applies only for dc power dissipation permitted by absolute maximum ratings.

μA7800 SERIES POSITIVE-VOLTAGE REGULATORS

SLVS056B – MAY 1976 – REVISED OCTOBER 1996

electrical characteristics at specified virtual junction temperature, $V_I = 19\text{ V}$, $I_O = 500\text{ mA}$ (unless otherwise noted)

PARAMETER	TEST CONDITIONS	T_J †	μA7812C			UNIT
			MIN	TYP	MAX	
Output voltage‡		25°C	11.5	12	12.5	V
	$I_O = 5\text{ mA to }1\text{ A}$, $V_I = 14.5\text{ V to }27\text{ V}$, $P \leq 15\text{ W}$	Full range§	11.4		12.6	
Input voltage regulation	$V_I = 14.5\text{ V to }30\text{ V}$	25°C		10	240	mV
	$V_I = 16\text{ V to }22\text{ V}$			3	120	
Ripple rejection	$V_I = 15\text{ V to }25\text{ V}$, $f = 120\text{ Hz}$	Full range§	55	71		dB
Output voltage regulation	$I_O = 5\text{ mA to }1.5\text{ A}$	25°C		12	240	mV
	$I_O = 250\text{ mA to }750\text{ mA}$			4	120	
Output resistance	$f = 1\text{ kHz}$	Full range§		0.018		Ω
Temperature coefficient of output voltage	$I_O = 5\text{ mA}$	Full range§		-1		mV/°C
Output noise voltage	$f = 10\text{ Hz to }100\text{ kHz}$	25°C		75		μV
Dropout voltage	$I_O = 1\text{ A}$	25°C		2		V
Bias current		25°C		4.3	8	mA
Bias current change	$V_I = 14.5\text{ V to }30\text{ V}$	Full range§			1	mA
	$I_O = 5\text{ mA to }1\text{ A}$				0.5	
Short-circuit output current		25°C		350		mA
Peak output current		25°C		2.2		A

† Pulse-testing techniques maintain the junction temperature as close to the ambient temperature as possible. Thermal effects must be taken into account separately. All characteristics are measured with a 0.33-μF capacitor across the input and a 0.1-μF capacitor across the output.

‡ This specification applies only for dc power dissipation permitted by absolute maximum ratings.

§ Full range virtual junction temperature is 0°C to 125°C for the μA7812C and -40°C to 125°C for the μA7812Q.

electrical characteristics at specified virtual junction temperature, $V_I = 23\text{ V}$, $I_O = 500\text{ mA}$ (unless otherwise noted)

PARAMETER	TEST CONDITIONS	T_J †	μA7815C			UNIT
			MIN	TYP	MAX	
Output voltage‡		25°C	14.4	15	15.6	V
	$I_O = 5\text{ mA to }1\text{ A}$, $V_I = 17.5\text{ V to }30\text{ V}$, $P \leq 15\text{ W}$	0°C to 125°C	14.25		15.75	
Input voltage regulation	$V_I = 17.5\text{ V to }30\text{ V}$	25°C		11	300	mV
	$V_I = 20\text{ V to }26\text{ V}$			3	150	
Ripple rejection	$V_I = 18.5\text{ V to }28.5\text{ V}$, $f = 120\text{ Hz}$	0°C to 125°C	54	70		dB
Output voltage regulation	$I_O = 5\text{ mA to }1.5\text{ A}$	25°C		12	300	mV
	$I_O = 250\text{ mA to }750\text{ mA}$			4	150	
Output resistance	$f = 1\text{ kHz}$	0°C to 125°C		0.019		Ω
Temperature coefficient of output voltage	$I_O = 5\text{ mA}$	0°C to 125°C		-1		mV/°C
Output noise voltage	$f = 10\text{ Hz to }100\text{ kHz}$	25°C		90		μV
Dropout voltage	$I_O = 1\text{ A}$	25°C		2		V
Bias current		25°C		4.4	8	mA
Bias current change	$V_I = 17.5\text{ V to }30\text{ V}$	0°C to 125°C			1	mA
	$I_O = 5\text{ mA to }1\text{ A}$				0.5	
Short-circuit output current		25°C		230		mA
Peak output current		25°C		2.1		A

† Pulse-testing techniques maintain the junction temperature as close to the ambient temperature as possible. Thermal effects must be taken into account separately. All characteristics are measured with a 0.33-μF capacitor across the input and a 0.1-μF capacitor across the output.

‡ This specification applies only for dc power dissipation permitted by absolute maximum ratings.



POST OFFICE BOX 655303 • DALLAS, TEXAS 75265

μA7800 SERIES POSITIVE-VOLTAGE REGULATORS

SLVS056B – MAY 1976 – REVISED OCTOBER 1996

electrical characteristics at specified virtual junction temperature, $V_I = 27\text{ V}$, $I_O = 500\text{ mA}$ (unless otherwise noted)

PARAMETER	TEST CONDITIONS	T_J †	μA7818C			UNIT
			MIN	TYP	MAX	
Output voltage‡	$I_O = 5\text{ mA to }1\text{ A}$, $P \leq 15\text{ W}$, $V_I = 21\text{ V to }33\text{ V}$	25°C	17.3	18	18.7	V
		0°C to 125°C	17.1		18.9	
Input voltage regulation	$V_I = 21\text{ V to }33\text{ V}$	25°C		15	360	mV
	$V_I = 24\text{ V to }30\text{ V}$			5	180	
Ripple rejection	$V_I = 22\text{ V to }32\text{ V}$, $f = 120\text{ Hz}$	0°C to 125°C	53	69		dB
Output voltage regulation	$I_O = 5\text{ mA to }1.5\text{ A}$	25°C		12	360	mV
	$I_O = 250\text{ mA to }750\text{ mA}$			4	180	
Output resistance	$f = 1\text{ kHz}$	0°C to 125°C		0.022		Ω
Temperature coefficient of output voltage	$I_O = 5\text{ mA}$	0°C to 125°C		-1		mV/°C
Output noise voltage	$f = 10\text{ Hz to }100\text{ kHz}$	25°C		110		μV
Dropout voltage	$I_O = 1\text{ A}$	25°C		2		V
Bias current		25°C		4.5	8	mA
Bias current change	$V_I = 21\text{ V to }33\text{ V}$	0°C to 125°C			1	mA
	$I_O = 5\text{ mA to }1\text{ A}$				0.5	
Short-circuit output current		25°C		200		mA
Peak output current		25°C		2.1		A

† Pulse-testing techniques maintain the junction temperature as close to the ambient temperature as possible. Thermal effects must be taken into account separately. All characteristics are measured with a 0.33-μF capacitor across the input and a 0.1-μF capacitor across the output.

‡ This specification applies only for dc power dissipation permitted by absolute maximum ratings.

electrical characteristics at specified virtual junction temperature, $V_I = 33\text{ V}$, $I_O = 500\text{ mA}$ (unless otherwise noted)

PARAMETER	TEST CONDITIONS	T_J †	μA7824C			UNIT
			MIN	TYP	MAX	
Output voltage‡	$I_O = 5\text{ mA to }1\text{ A}$, $P \leq 15\text{ W}$, $V_I = 27\text{ V to }38\text{ V}$	25°C	23	24	25	V
		0°C to 125°C	22.8		25.2	
Input voltage regulation	$V_I = 27\text{ V to }38\text{ V}$	25°C		18	480	mV
	$V_I = 30\text{ V to }36\text{ V}$			6	240	
Ripple rejection	$V_I = 28\text{ V to }38\text{ V}$, $f = 120\text{ Hz}$	0°C to 125°C	50	66		dB
Output voltage regulation	$I_O = 5\text{ mA to }1.5\text{ A}$	25°C		12	480	mV
	$I_O = 250\text{ mA to }750\text{ mA}$			4	240	
Output resistance	$f = 1\text{ kHz}$	0°C to 125°C		0.028		Ω
Temperature coefficient of output voltage	$I_O = 5\text{ mA}$	0°C to 125°C		-1.5		mV/°C
Output noise voltage	$f = 10\text{ Hz to }100\text{ kHz}$	25°C		170		μV
Dropout voltage	$I_O = 1\text{ A}$	25°C		2		V
Bias current		25°C		4.6	8	mA
Bias current change	$V_I = 27\text{ V to }38\text{ V}$	0°C to 125°C			1	mA
	$I_O = 5\text{ mA to }1\text{ A}$				0.5	
Short-circuit output current		25°C		150		mA
Peak output current		25°C		2.1		A

† Pulse-testing techniques maintain the junction temperature as close to the ambient temperature as possible. Thermal effects must be taken into account separately. All characteristics are measured with a 0.33-μF capacitor across the input and a 0.1-μF capacitor across the output.

‡ This specification applies only for dc power dissipation permitted by absolute maximum ratings.



POST OFFICE BOX 655303 • DALLAS, TEXAS 75265

μA7800 SERIES POSITIVE-VOLTAGE REGULATORS

SLVS056B – MAY 1976 – REVISED OCTOBER 1996

electrical characteristics at specified virtual junction temperature, $V_I = 10\text{ V}$, $I_O = 500\text{ mA}$, $T_J = 25^\circ\text{C}$
(unless otherwise noted)

PARAMETER	TEST CONDITIONS	μA7805Y			UNIT
		MIN	TYP	MAX	
Output voltage [†]			5		V
Input voltage regulation	$V_I = 7\text{ V to }25\text{ V}$		3		mV
	$V_I = 8\text{ V to }12\text{ V}$		1		
Ripple rejection	$V_I = 8\text{ V to }18\text{ V}$, $f = 120\text{ Hz}$		78		dB
Output voltage regulation	$I_O = 5\text{ mA to }1.5\text{ A}$		15		mV
	$I_O = 250\text{ mA to }750\text{ mA}$		5		
Output resistance	$f = 1\text{ kHz}$		0.017		Ω
Temperature coefficient of output voltage	$I_O = 5\text{ mA}$		-1.1		mV/°C
Output noise voltage	$f = 10\text{ Hz to }100\text{ kHz}$		40		μV
Dropout voltage	$I_O = 1\text{ A}$		2		V
			4.2		mA
			750		mA
			2.2		A

[†] Pulse-testing techniques maintain the junction temperature as close to the ambient temperature as possible. Thermal effects must be taken into account separately. All characteristics are measured with a 0.33-μF capacitor across the input and a 0.1-μF capacitor across the output.

[‡] This specification applies only for dc power dissipation permitted by absolute maximum ratings.

electrical characteristics at specified virtual junction temperature, $V_I = 11\text{ V}$, $I_O = 500\text{ mA}$, $T_J = 25^\circ\text{C}$
(unless otherwise noted)

PARAMETER	TEST CONDITIONS	μA7806Y			UNIT
		MIN	TYP	MAX	
Output voltage [†]			6		V
Input voltage regulation	$V_I = 8\text{ V to }25\text{ V}$		5		mV
	$V_I = 9\text{ V to }13\text{ V}$		1.5		
Ripple rejection	$V_I = 9\text{ V to }19\text{ V}$, $f = 120\text{ Hz}$		75		dB
Output voltage regulation	$I_O = 5\text{ mA to }1.5\text{ A}$		14		mV
	$I_O = 250\text{ mA to }750\text{ mA}$		4		
Output resistance	$f = 1\text{ kHz}$		0.019		Ω
Temperature coefficient of output voltage	$I_O = 5\text{ mA}$		-0.8		mV/°C
Output noise voltage	$f = 10\text{ Hz to }100\text{ kHz}$		45		μV
Dropout voltage	$I_O = 1\text{ A}$		2		V
Bias current			4.3		mA
Short-circuit output current			550		mA
Peak output current			2.2		A

[†] Pulse-testing techniques maintain the junction temperature as close to the ambient temperature as possible. Thermal effects must be taken into account separately. All characteristics are measured with a 0.33-μF capacitor across the input and a 0.1-μF capacitor across the output.

[‡] This specification applies only for dc power dissipation permitted by absolute maximum ratings.



POST OFFICE BOX 655303 • DALLAS, TEXAS 75265

μA7800 SERIES POSITIVE-VOLTAGE REGULATORS

SLVS056B – MAY 1976 – REVISED OCTOBER 1996

electrical characteristics at specified virtual junction temperature, $V_I = 14\text{ V}$, $I_O = 500\text{ mA}$, $T_J = 25^\circ\text{C}^\dagger$
(unless otherwise noted)

PARAMETER	TEST CONDITIONS	μA7808Y			UNIT
		MIN	TYP	MAX	
Output voltage [‡]			8		V
Input voltage regulation	$V_I = 10.5\text{ V to }25\text{ V}$		6		mV
	$V_I = 11\text{ V to }17\text{ V}$		2		
Ripple rejection	$V_I = 11.5\text{ V to }21.5\text{ V}$, $f = 120\text{ Hz}$		72		dB
Output voltage regulation	$I_O = 5\text{ mA to }1.5\text{ A}$		12		mV
	$I_O = 250\text{ mA to }750\text{ mA}$		4		
Output resistance	$f = 1\text{ kHz}$		0.016		Ω
Temperature coefficient of output voltage	$I_O = 5\text{ mA}$		-0.8		mV/°C
Output noise voltage	$f = 10\text{ Hz to }100\text{ kHz}$		52		μV
Dropout voltage	$I_O = 1\text{ A}$		2		V
Bias current			4.3		mA
Short-circuit output current			450		mA
Peak output current			2.2		A

[†] Pulse-testing techniques maintain the junction temperature as close to the ambient temperature as possible. Thermal effects must be taken into account separately. All characteristics are measured with a 0.33-μF capacitor across the input and a 0.1-μF capacitor across the output.

[‡] This specification applies only for dc power dissipation permitted by absolute maximum ratings.

electrical characteristics at specified virtual junction temperature, $V_I = 15\text{ V}$, $I_O = 500\text{ mA}$, $T_J = 25^\circ\text{C}^\dagger$
(unless otherwise noted)

PARAMETER	TEST CONDITIONS	μA7885Y			UNIT
		MIN	TYP	MAX	
Output voltage [‡]			8.5		V
Input voltage regulation	$V_I = 10.5\text{ V to }25\text{ V}$		6		mV
	$V_I = 11\text{ V to }17\text{ V}$		2		
Ripple rejection	$V_I = 11.5\text{ V to }21.5\text{ V}$, $f = 120\text{ Hz}$		70		dB
Output voltage regulation	$I_O = 5\text{ mA to }1.5\text{ A}$		12		mV
	$I_O = 250\text{ mA to }750\text{ mA}$		4		
Output resistance	$f = 1\text{ kHz}$		0.016		Ω
Temperature coefficient of output voltage	$I_O = 5\text{ mA}$		-0.8		mV/°C
Output noise voltage	$f = 10\text{ Hz to }100\text{ kHz}$		55		μV
Dropout voltage	$I_O = 1\text{ A}$		2		V
Bias current			4.3		mA
Short-circuit output current			450		mA
Peak output current			2.2		A

[†] Pulse-testing techniques maintain the junction temperature as close to the ambient temperature as possible. Thermal effects must be taken into account separately. All characteristics are measured with a 0.33-μF capacitor across the input and a 0.1-μF capacitor across the output.

[‡] This specification applies only for dc power dissipation permitted by absolute maximum ratings.

μA7800 SERIES POSITIVE-VOLTAGE REGULATORS

SLVS056B – MAY 1976 – REVISED OCTOBER 1996

electrical characteristics at specified virtual junction temperature, $V_I = 17\text{ V}$, $I_O = 500\text{ mA}$, $T_J = 25^\circ\text{C}^\dagger$
(unless otherwise noted)

PARAMETER	TEST CONDITIONS	μA7810Y			UNIT
		MIN	TYP	MAX	
Output voltage [‡]			10		V
Input voltage regulation	$V_I = 12.5\text{ V to }28\text{ V}$		7		mV
	$V_I = 14\text{ V to }20\text{ V}$		2		
Ripple rejection	$V_I = 13\text{ V to }23\text{ V}$, $f = 120\text{ Hz}$		71		dB
Output voltage regulation	$I_O = 5\text{ mA to }1.5\text{ A}$		12		mV
	$I_O = 250\text{ mA to }750\text{ mA}$		4		
Output resistance	$f = 1\text{ kHz}$		0.018		Ω
Temperature coefficient of output voltage	$I_O = 5\text{ mA}$		-1		mV/°C
Output noise voltage	$f = 10\text{ Hz to }100\text{ kHz}$		70		μV
	$I_O = 1\text{ A}$		2		
			4.3		mA
			400		mA
			2.2		A

[†] Pulse-testing techniques maintain the junction temperature as close to the ambient temperature as possible. Thermal effects must be taken into account separately. All characteristics are measured with a 0.33-μF capacitor across the input and a 0.1-μF capacitor across the output.

[‡] This specification applies only for dc power dissipation permitted by absolute maximum ratings.

electrical characteristics at specified virtual junction temperature, $V_I = 19\text{ V}$, $I_O = 500\text{ mA}$, $T_J = 25^\circ\text{C}^\dagger$
(unless otherwise noted)

PARAMETER	TEST CONDITIONS	μA7812Y			UNIT
		MIN	TYP	MAX	
Output voltage [‡]			12		V
Input voltage regulation	$V_I = 14.5\text{ V to }30\text{ V}$		10		mV
	$V_I = 16\text{ V to }22\text{ V}$		3		
Ripple rejection	$V_I = 15\text{ V to }25\text{ V}$, $f = 120\text{ Hz}$		71		dB
Output voltage regulation	$I_O = 5\text{ mA to }1.5\text{ A}$		12		mV
	$I_O = 250\text{ mA to }750\text{ mA}$		4		
Output resistance	$f = 1\text{ kHz}$		0.018		Ω
Temperature coefficient of output voltage	$I_O = 5\text{ mA}$		-1		mV/°C
Output noise voltage	$f = 10\text{ Hz to }100\text{ kHz}$		75		μV
Dropout voltage	$I_O = 1\text{ A}$		2		V
Bias current			4.3		mA
Short-circuit output current			350		mA
Peak output current			2.2		A

[†] Pulse-testing techniques maintain the junction temperature as close to the ambient temperature as possible. Thermal effects must be taken into account separately. All characteristics are measured with a 0.33-μF capacitor across the input and a 0.1-μF capacitor across the output.

[‡] This specification applies only for dc power dissipation permitted by absolute maximum ratings.



POST OFFICE BOX 655303 • DALLAS, TEXAS 75265

μA7800 SERIES POSITIVE-VOLTAGE REGULATORS

SLVS056B – MAY 1976 – REVISED OCTOBER 1996

electrical characteristics at specified virtual junction temperature, $V_I = 23\text{ V}$, $I_O = 500\text{ mA}$, $T_J = 25^\circ\text{C}^\dagger$
(unless otherwise noted)

PARAMETER	TEST CONDITIONS	μA7815Y			UNIT
		MIN	TYP	MAX	
Output voltage [‡]			15		V
Input voltage regulation	$V_I = 17.5\text{ V to }30\text{ V}$		11		mV
	$V_I = 20\text{ V to }26\text{ V}$		3		
Ripple rejection	$V_I = 18.5\text{ V to }28.5\text{ V}$, $f = 120\text{ Hz}$		70		dB
Output voltage regulation	$I_O = 5\text{ mA to }1.5\text{ A}$		12		mV
	$I_O = 250\text{ mA to }750\text{ mA}$		4		
Output resistance	$f = 1\text{ kHz}$		0.019		Ω
Temperature coefficient of output voltage	$I_O = 5\text{ mA}$		-1		mV/°C
Output noise voltage	$f = 10\text{ Hz to }100\text{ kHz}$		90		μV
Dropout voltage	$I_O = 1\text{ A}$		2		V
Bias current			4.4		mA
Short-circuit output current			230		mA
Peak output current			2.1		A

[†] Pulse-testing techniques maintain the junction temperature as close to the ambient temperature as possible. Thermal effects must be taken into account separately. All characteristics are measured with a 0.33-μF capacitor across the input and a 0.1-μF capacitor across the output.

[‡] This specification applies only for dc power dissipation permitted by absolute maximum ratings.

electrical characteristics at specified virtual junction temperature, $V_I = 27\text{ V}$, $I_O = 500\text{ mA}$, $T_J = 25^\circ\text{C}^\dagger$
(unless otherwise noted)

PARAMETER	TEST CONDITIONS	μA7818Y			UNIT
		MIN	TYP	MAX	
Output voltage [‡]			18		V
Input voltage regulation	$V_I = 21\text{ V to }33\text{ V}$		15		mV
	$V_I = 24\text{ V to }30\text{ V}$		5		
Ripple rejection	$V_I = 22\text{ V to }32\text{ V}$, $f = 120\text{ Hz}$		69		dB
Output voltage regulation	$I_O = 5\text{ mA to }1.5\text{ A}$		12		mV
	$I_O = 250\text{ mA to }750\text{ mA}$		4		
Output resistance	$f = 1\text{ kHz}$		0.022		Ω
Temperature coefficient of output voltage	$I_O = 5\text{ mA}$		-1		mV/°C
Output noise voltage	$f = 10\text{ Hz to }100\text{ kHz}$		110		μV
Dropout voltage	$I_O = 1\text{ A}$		2		V
Bias current			4.5		mA
Short-circuit output current			200		mA
Peak output current			2.1		A

[†] Pulse-testing techniques maintain the junction temperature as close to the ambient temperature as possible. Thermal effects must be taken into account separately. All characteristics are measured with a 0.33-μF capacitor across the input and a 0.1-μF capacitor across the output.

[‡] This specification applies only for dc power dissipation permitted by absolute maximum ratings.



POST OFFICE BOX 655303 • DALLAS, TEXAS 75265

μA7800 SERIES POSITIVE-VOLTAGE REGULATORS

SLVS056B – MAY 1976 – REVISED OCTOBER 1996

electrical characteristics at specified virtual junction temperature, $V_I = 33\text{ V}$, $I_O = 500\text{ mA}$, $T_J = 25^\circ\text{C}^\dagger$
(unless otherwise noted)

PARAMETER	TEST CONDITIONS	μA7824Y			UNIT
		MIN	TYP	MAX	
Output voltage [‡]			24		V
Input voltage regulation	$V_I = 27\text{ V to }38\text{ V}$		18		mV
	$V_I = 30\text{ V to }36\text{ V}$		6		
Ripple rejection	$V_I = 28\text{ V to }38\text{ V}$, $f = 120\text{ Hz}$		66		dB
Output voltage regulation	$I_O = 5\text{ mA to }1.5\text{ A}$		12		mV
	$I_O = 250\text{ mA to }750\text{ mA}$		4		
Output resistance	$f = 1\text{ kHz}$		0.028		Ω
Temperature coefficient of output voltage	$I_O = 5\text{ mA}$		-1.5		mV/°C
Output noise voltage	$f = 10\text{ Hz to }100\text{ kHz}$		170		μV
	$I_O = 1\text{ A}$		2		V
			4.6		mA
			150		mA
			2.1		A

[†] Pulse-testing techniques maintain the junction temperature as close to the ambient temperature as possible. Thermal effects must be taken into account separately. All characteristics are measured with a 0.33-μF capacitor across the input and a 0.1-μF capacitor across the output.

[‡] This specification applies only for dc power dissipation permitted by absolute maximum ratings.



POST OFFICE BOX 655303 • DALLAS, TEXAS 75265

APPLICATION INFORMATION

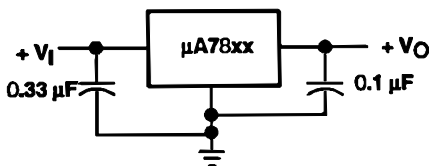

Figure 3. Fixed Output Regulator

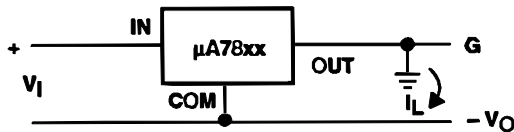
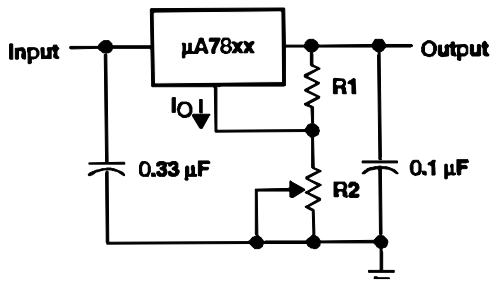

Figure 4. Positive Regulator in Negative Configuration (V_I Must Float)



NOTE A: The following formula is used when V_{xx} is the nominal output voltage (output to common) of the fixed regulator.

$$V_O = V_{xx} + \left(\frac{V_{xx}}{R1} + I_Q \right) R2$$

Figure 5. Adjustable Output Regulator

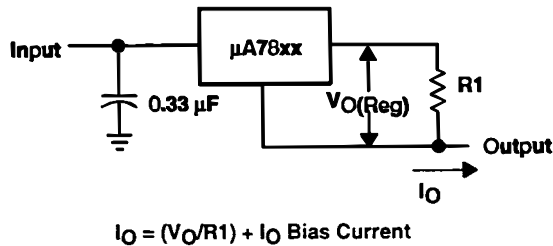

$$I_O = (V_O/R1) + I_O \text{ Bias Current}$$

Figure 6. Current Regulator

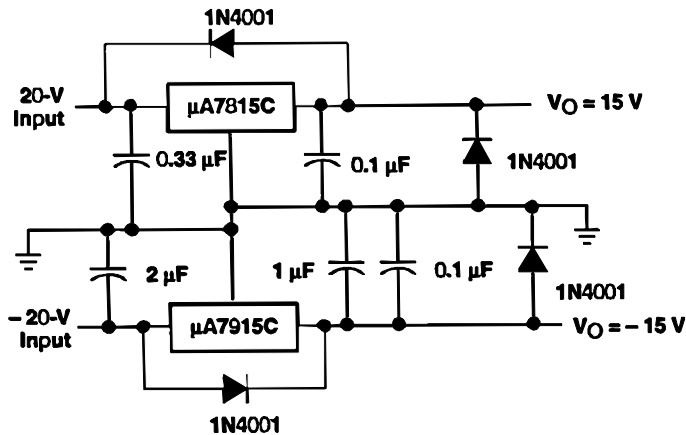

Figure 7. Regulated Dual Supply

μ A7800 SERIES POSITIVE-VOLTAGE REGULATORS

SLVS056B – MAY 1976 – REVISED OCTOBER 1996

APPLICATION INFORMATION

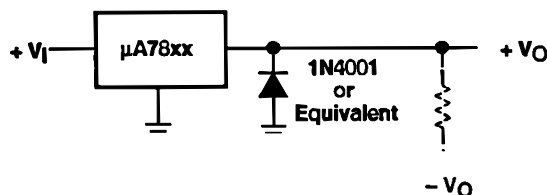

Figure 8. Output Polarity-Reversal Protection Circuit

operation with a load common to a voltage of opposite polarity

In many cases, a regulator powers a load that is not connected to ground but instead is connected to a voltage source of opposite polarity (e.g., op amps, level-shifting circuits, etc.). In these cases, a clamp diode should be connected to the regulator output as shown in Figure 8. This protects the regulator from output polarity reversals during startup and short-circuit operation.

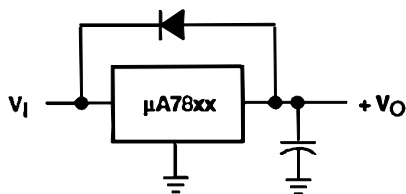

Figure 9. Reverse-Bias Protection Circuit

reverse-bias protection

Occasionally, there exists the possibility that the input voltage to the regulator can collapse faster than the output voltage. This could occur, for example, when the input supply is crowbarred during an output overvoltage condition. If the output voltage is greater than approximately 7 V, the emitter-base junction of the series pass element (internal or external) could break down and be damaged. To prevent this, a diode shunt can be employed as shown in Figure 9.

MECHANICAL INFORMATION

KC (R-PSFM-T3)

PLASTIC FLANGE-MOUNT PACKAGE

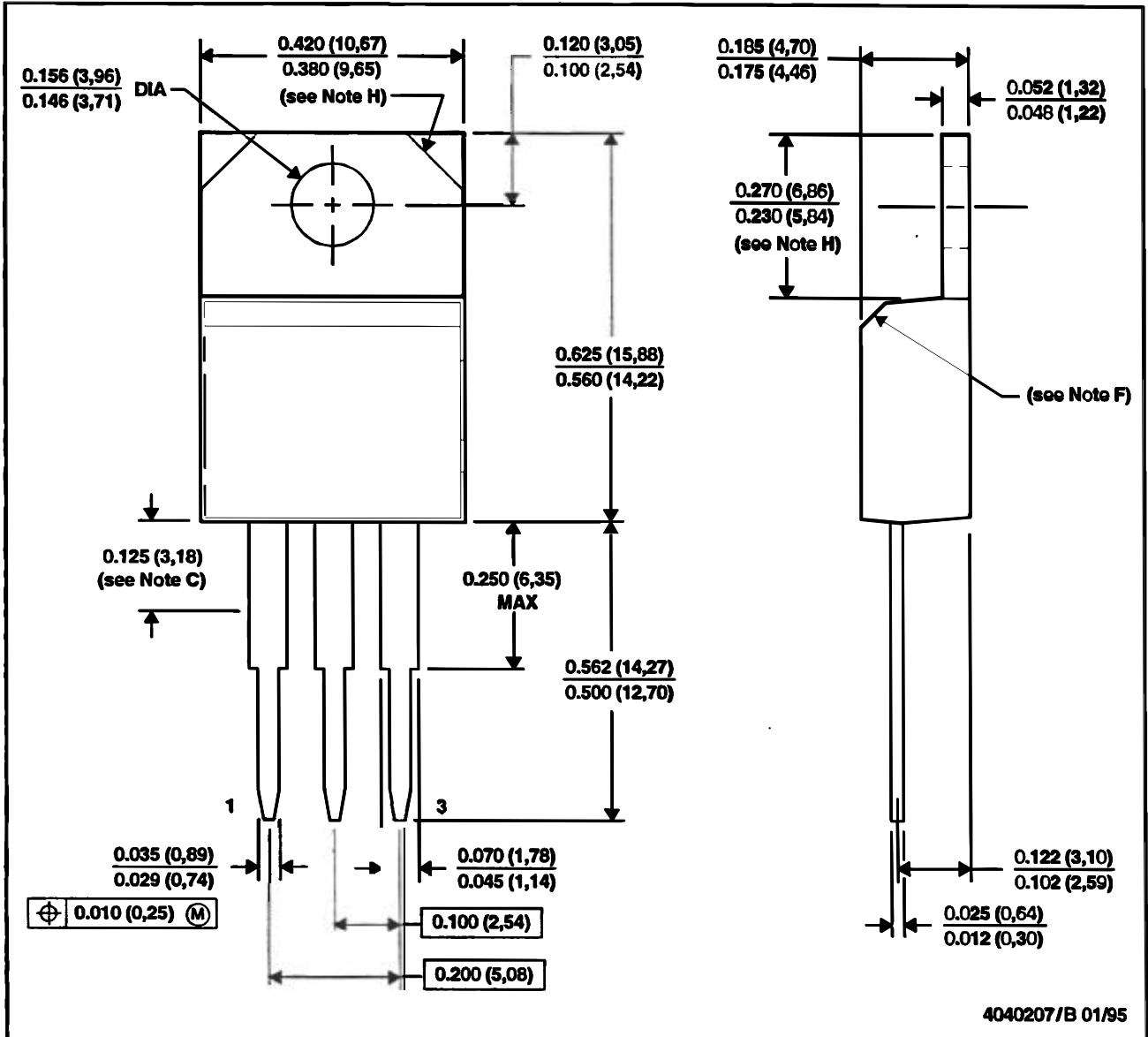

- NOTES:
- B. All linear dimensions are in inches (millimeters).
 - C. This drawing is subject to change without notice.
 - D. Lead dimensions are not controlled within this area.
 - E. All lead dimensions apply before solder dip.
 - F. The center lead is in electrical contact with the mounting tab.
 - G. The chamfer is optional.
 - H. Falls within JEDEC TO-220AB
 - I. Tab contour optional within these dimensions

**μA7800 SERIES
POSITIVE-VOLTAGE REGULATORS**

SLVS056B – MAY 1976 – REVISED OCTOBER 1996

MECHANICAL INFORMATION

KTE (R-PSFM-T3)

PLASTIC FLANGE-MOUNT PACKAGE

