

SN54122, SN54123, SN54130, SN54LS122, SN54LS123, SN74122, SN74123, SN74130, SN74LS122, SN74LS123 RETRIGGERABLE MONOSTABLE MULTIVIBRATORS

SDLS043 - DECEMBER 1983 - REVISED MARCH 1988

- D-C Triggered from Active-High or Active-Low Gated Logic Inputs
- Retriggerable for Very Long Output Pulses, Up to 100% Duty Cycle
- Overriding Clear Terminates Output Pulse
- '122 and 'LS122 Have Internal Timing Resistors

description

These d-c triggered multivibrators feature output pulse-duration control by three methods. The basic pulse time is programmed by selection of external resistance and capacitance values (see typical application data). The '122 and 'LS122 have internal timing resistors that allow the circuits to be used with only an external capacitor, if so desired. Once triggered, the basic pulse duration may be extended by retriggering the gated low-level-active (A) or high-level-active (B) inputs, or be reduced by use of the overriding clear. Figure 1 illustrates pulse control by retriggering and early clear.

The 'LS122 and 'LS123 are provided enough Schmitt hysteresis to ensure jitter-free triggering from the B input with transition rates as slow as 0.1 millivolt per nanosecond.

The R_{int} is nominal 10 k Ω for '122 and 'LS122.

SN54123, SN54130, SN54LS123 . . . J OR W PACKAGE
SN74123, SN74130 . . . N PACKAGE
SN74LS123 . . . D OR N PACKAGE
(TOP VIEW) (SEE NOTES 1 THRU 4)

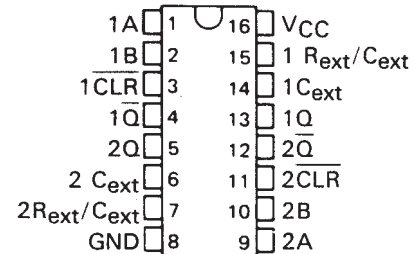

SN54LS122 . . . FK PACKAGE
(TOP VIEW) (SEE NOTES 1 THRU 4)



SN54122, SN54LS122 . . . J OR W PACKAGE
SN74122 . . . N PACKAGE
SN74LS122 . . . D OR N PACKAGE
(TOP VIEW) (SEE NOTES 1 THRU 4)



- NOTES: 1. An external timing capacitor may be connected between C_{ext} and R_{ext}/C_{ext} (positive).
2. To use the internal timing resistor of '122 or 'LS122, connect R_{int} to V_{CC} .
3. For improved pulse duration accuracy and repeatability, connect an external resistor between R_{ext}/C_{ext} and V_{CC} with R_{int} open-circuited.
4. To obtain variable pulse durations, connect an external variable resistance between R_{int} or R_{ext}/C_{ext} and V_{CC} .

SN54LS123 . . . FK PACKAGE
(TOP VIEW) (SEE NOTES 1 THRU 4)



NC - No internal connection

PRODUCTION DATA information is current as of publication date. Products conform to specifications per the terms of Texas Instruments standard warranty. Production processing does not necessarily include testing of all parameters.

 **TEXAS
INSTRUMENTS**

POST OFFICE BOX 655303 • DALLAS, TEXAS 75265

**SN54122, SN54123, SN54130, SN54LS122, SN54LS123,
SN74122, SN74123, SN74130, SN74LS122, SN74LS123
RETRIGGERABLE MONOSTABLE MULTIVIBRATORS**

SDLS043 – DECEMBER 1983 – REVISED MARCH 1988

description (continued)

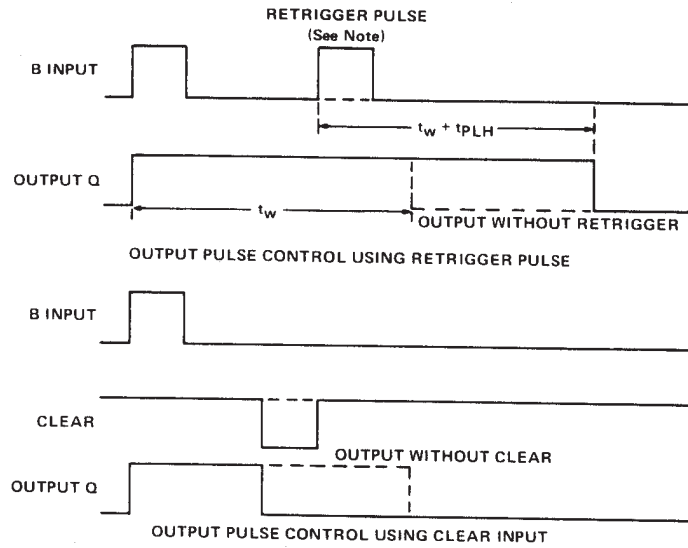

NOTE: Retrigger pulses starting before $0.22 C_{ext}$ (in picoseconds) nanoseconds after the initial trigger pulse will be ignored and the output duration will remain unchanged.

FIGURE 1—TYPICAL INPUT/OUTPUT PULSES

'122, 'LS122
FUNCTION TABLE

INPUTS					OUTPUTS	
CLEAR	A1	A2	B1	B2	Q	\bar{Q}
L	X	X	X	X	L	H
X	H	H	X	X	L [†]	H [†]
X	X	X	L	X	L [†]	H [†]
X	X	X	X	L	L [†]	H [†]
H	L	X	↑	H	\square	\sqcup
H	L	X	H	↑	\square	\sqcup
H	X	L	↑	H	\square	\sqcup
H	X	L	H	↑	\square	\sqcup
H	H	↓	H	H	\square	\sqcup
H	↓	↓	H	H	\square	\sqcup
H	↓	H	H	H	\square	\sqcup
↑	L	X	H	H	\square	\sqcup
↑	X	L	H	H	\square	\sqcup

'123, '130, 'LS123
FUNCTION TABLE

INPUTS			OUTPUTS	
CLEAR	A	B	Q	\bar{Q}
L	X	X	L	H
X	H	X	L [†]	H [†]
X	X	L	L [†]	H [†]
H	L	↑	\square	\sqcup
H	↓	H	\square	\sqcup
↑	L	H	\square	\sqcup

See explanation of function tables on page

† These lines of the functional tables assume that the indicated steady-state conditions at the A and B inputs have been set up long enough to complete any pulse started before the set up.



SN54122, SN54123, SN54130, SN54LS122, SN54LS123,
 SN74122, SN74123, SN74130, SN74LS122, SN74LS123
 RETRIGGERABLE MONOSTABLE MULTIVIBRATORS

SDLS043 - DECEMBER 1983 - REVISED MARCH 1988

logic diagram (positive logic)

logic symbol†



R_{int} is nominally 10 k Ω for '122 and 'LS122

logic diagram (positive logic) (each multivibrator)

logic symbol†



Pin numbers shown are for D, J, N, and W packages.

†These symbols are in accordance with ANSI/IEEE Std 91-1984 and IEC Publication 617-12.

SN54122, SN54123, SN54130, SN54LS122, SN54LS123, SN74122, SN74123, SN74130, SN74LS122, SN74LS123 RETRIGGERABLE MONOSTABLE MULTIVIBRATORS

SDLS043 - DECEMBER 1983 - REVISED MARCH 1988

schematics of inputs and outputs

'122, '123, '130 CIRCUITS

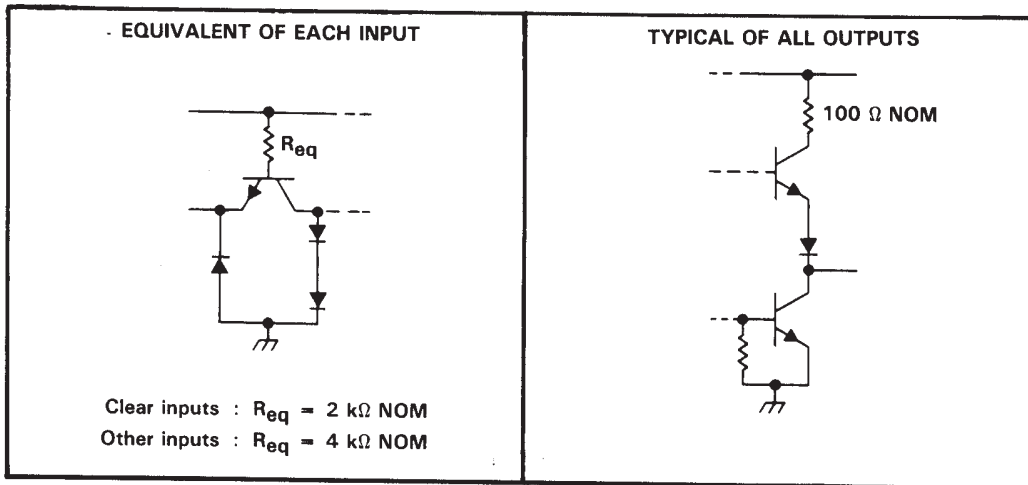

'LS122, 'LS123 CIRCUITS

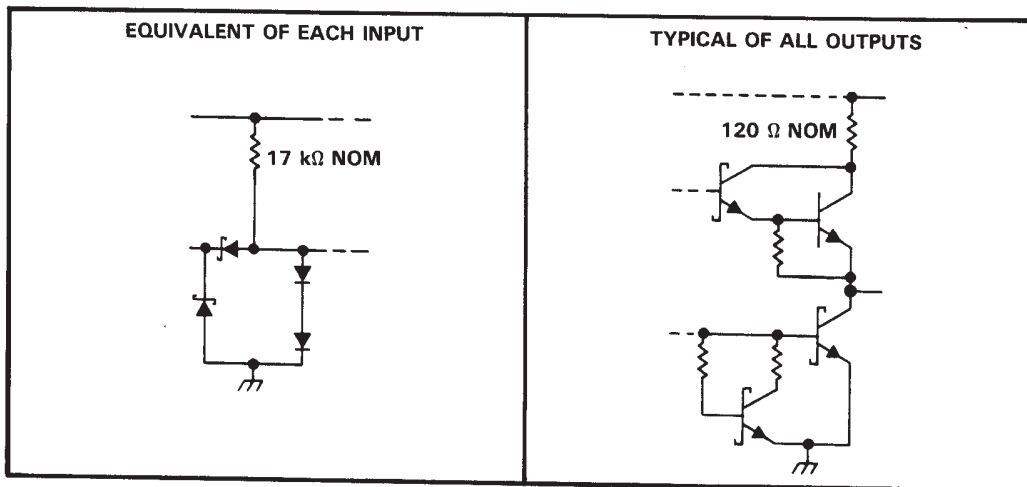

absolute maximum ratings over operating free-air temperature range (unless otherwise noted)

Supply voltage, V_{CC} (see Note 1)	7 V
Input voltage: '122, '123, '130	5.5 V
'LS122, 'LS123	7 V
Operating free-air temperature range: SN54'	-55°C to 125°C
SN74'	0°C to 70°C
Storage temperature range	-65°C to 150°C

NOTE 1: Voltage values are with respect to network ground terminal.

SN54122, SN54123, SN54130, SN74122, SN74123, SN74130 RETRIGGERABLE MONOSTABLE MULTIVIBRATORS

SDLS043 – DECEMBER 1983 – REVISED MARCH 1988

recommended operating conditions

	SN54'			SN74'			UNIT
	MIN	NOM	MAX	MIN	NOM	MAX	
Supply voltage, V_{CC}	4.5	5	5.5	4.75	5	5.25	V
High-level output current, I_{OH}	-800			-800			μA
Low-level output current, I_{OL}	16			16			mA
Pulse duration, t_w	40			40			ns
External timing resistance, R_{ext}	5			25			$k\Omega$
External capacitance, C_{ext}	No restriction			No restriction			
Wiring capacitance at R_{ext}/C_{ext} terminal	50			50			pF
Operating free-air temperature, T_A	-55			125			$^{\circ}C$

electrical characteristics over recommended free-air operating temperature range (unless otherwise noted)

PARAMETER	TEST CONDITIONS†	'122			'123, '130			UNIT
		MIN	TYP‡	MAX	MIN	TYP‡	MAX	
V_{IH} High-level input voltage		2			2			V
V_{IL} Low-level input voltage		0.8			0.8			V
V_{IK} Input clamp voltage	$V_{CC} = \text{MIN}, I_I = -12 \text{ mA}$	-1.5			-1.5			V
V_{OH} High-level output voltage	$V_{CC} = \text{MIN}, I_{OH} = -800 \mu A$, See Note 5	2.4	3.4		2.4	3.4		V
V_{OL} Low-level output voltage	$V_{CC} = \text{MIN}, I_{OL} = 16 \text{ mA}$, See Note 5	0.2	0.4		0.2	0.4		V
I_I Input current at maximum input voltage	$V_{CC} = \text{MAX}, V_I = 5.5 \text{ V}$	1			1			mA
I_{IH} High-level input current	Data inputs	40			40			μA
	Clear input	80			80			
I_{IL} Low-level input current	Data inputs	-1.6			-1.6			mA
	Clear input	-3.2			-3.2			
I_{OS} Short-circuit output current‡	$V_{CC} = \text{MAX}$, See Note 5	-10			-10			mA
I_{CC} Supply current (quiescent or triggered)	$V_{CC} = \text{MAX}$, See Notes 6 and 7	23	36		46	66		mA

† For conditions shown as MIN or MAX, use the appropriate value specified under recommended operating conditions.

‡ All typical values are at $V_{CC} = 5 \text{ V}, T_A = 25^{\circ}C$.

§ Not more than one output should be shorted at a time.

NOTES: 5. Ground C_{ext} to measure V_{OH} at Q, V_{OL} at \bar{Q} , or I_{OS} at Q. C_{ext} is open to measure V_{OH} at \bar{Q} , V_{OL} at Q, or I_{OS} at \bar{Q} .

6. Quiescent I_{CC} is measured (after clearing) with 4.5 V applied to all clear and A inputs, B inputs grounded, all outputs open and $R_{ext} = 25 \text{ k}\Omega$. R_{int} of '122 is open.

7. I_{CC} is measured in the triggered state with 2.4 V applied to all clear and B inputs, A inputs grounded, all outputs open, $C_{ext} = 0.02 \mu F$, and $R_{ext} = 25 \text{ k}\Omega$. R_{int} of '122 is open.

switching characteristics, $V_{CC} = 5 \text{ V}, T_A = 25^{\circ}C$, see note 8

PARAMETER¶	FROM (INPUT)	TO (OUTPUT)	TEST CONDITIONS	'122, '130			'123			UNIT
				MIN	TYP	MAX	MIN	TYP	MAX	
t_{PLH}	A	Q	$C_{ext} = 0, R_{ext} = 5 \text{ k}\Omega,$ $C_L = 15 \text{ pF}, R_L = 400 \Omega$	22	33		22	33	ns	
	B			19	28		19	28		
t_{PHL}	A	\bar{Q}		30	40		30	40	ns	
	B			27	36		27	36		
t_{PHL}	Clear	Q		18	27		18	27	ns	
t_{PLH}		\bar{Q}		30	40		30	40		
$t_{wQ}(\text{min})$	A or B	Q		45	65		45	76	ns	
t_{wQ}	A or B	Q		3.08	3.42	3.76	2.76	3.03	3.37	μs

¶ t_{PLH} = propagation delay time, low-to-high-level output

t_{PHL} = propagation delay time, high-to-low-level output

t_{wQ} = duration of pulse at output Q.

NOTE 8: Load circuits and voltage waveforms are shown in Section 1.



SN54LS122, SN54LS123, SN74LS122, SN74LS123 RETRIGGERABLE MONOSTABLE MULTIVIBRATORS

SDLS043 – DECEMBER 1983 – REVISED MARCH 1988

recommended operating conditions

	SN54LS'			SN74LS'			UNIT
	MIN	NOM	MAX	MIN	NOM	MAX	
Supply voltage, V_{CC}	4.5	5	5.5	4.75	5	5.25	V
High-level output current, I_{OH}			-400			-400	μ A
Low-level output current, I_{OL}			4			8	mA
Pulse duration, t_w	40			40			ns
External timing resistance, R_{ext}	5		180	5		260	k Ω
External capacitance, C_{ext}	No restriction			No restriction			
Wiring capacitance at R_{ext}/C_{ext} terminal			50			50	pF
Operating free-air temperature, T_A	-55		125	0		70	$^{\circ}$ C

electrical characteristics over recommended operating free-air temperature range (unless otherwise noted)

PARAMETER	TEST CONDITIONS†	SN54LS'			SN74LS'			UNIT
		MIN	TYP‡	MAX	MIN	TYP‡	MAX	
V_{IH} High-level input voltage		2			2			V
V_{IL} Low-level input voltage				0.7			0.8	V
V_{IK} Input clamp voltage	$V_{CC} = \text{MIN}, I_I = -18 \text{ mA}$			-1.5			-1.5	V
V_{OH} High-level output voltage	$V_{CC} = \text{MIN}, V_{IL} = V_{IL \text{ max}}, I_{OH} = -400 \mu\text{A}$	2.5	3.5		2.7	3.5		V
V_{OL} Low-level output voltage	$V_{CC} = \text{MIN}, V_{IH} = 2 \text{ V}, V_{IL} = V_{IL \text{ max}}$			0.25	0.4		0.25	0.4
							0.35	0.5
I_I Input current at maximum input voltage	$V_{CC} = \text{MAX}, V_I = 7 \text{ V}$			0.1			0.1	mA
I_{IH} High-level input current	$V_{CC} = \text{MAX}, V_I = 2.7 \text{ V}$			20			20	μ A
I_{IL} Low-level input current	$V_{CC} = \text{MAX}, V_I = 0.4 \text{ V}$			-0.4			-0.4	mA
I_{OS} Short-circuit output current§	$V_{CC} = \text{MAX}$	-20		-100	-20		-100	mA
I_{CC} Supply current (quiescent or triggered)	$V_{CC} = \text{MAX},$ See Note 13			6	11		6	11
				12	20		12	20

†For conditions shown as MIN or MAX, use the appropriate value specified under recommended operating conditions.

‡All typical values are at $V_{CC} = 5 \text{ V}, T_A = 25^{\circ}\text{C}$.

§Not more than one output should be shorted at a time and duration of the short-circuit should not exceed one second.

NOTES: 12. To measure V_{OH} at Q, V_{OL} at Q, or I_{OS} at Q, ground R_{ext}/C_{ext} , apply 2 V to B and clear, and pulse A from 2 V to 0 V.
13. With all outputs open and 4.5 V applied to all data and clear inputs. I_{CC} is measured after a momentary ground, then 4.5 V, is applied to A or B inputs.

switching characteristics, $V_{CC} = 5 \text{ V}, T_A = 25^{\circ}\text{C}$ (see note 8)

PARAMETER¶	FROM (INPUT)	TO (OUTPUT)	TEST CONDITIONS	MIN	TYP	MAX	UNIT
t_{PLH}	A	Q	$C_{ext} = 0, R_{ext} = 5 \text{ k}\Omega, C_L = 15 \text{ pF}, R_L = 2 \text{ k}\Omega$	23	33	ns	
	B			23	44		
t_{PHL}	A	\bar{Q}		32	45	ns	
	B	\bar{Q}		34	56		
t_{PHL}	Clear	Q		20	27	ns	
t_{PLH}		\bar{Q}		28	45		
$t_{wQ}(\text{min})$	A or B	Q			116	200	ns
t_{wQ}	A or B	Q		$C_{ext} = 1000 \text{ pF}, C_L = 15 \text{ pF}, R_{ext} = 10 \text{ k}\Omega, R_L = 2 \text{ k}\Omega$	4	4.5	5

¶ t_{PLH} = propagation delay time, low-to-high-level output

t_{PHL} = propagation delay time, high-to-low-level output

t_{wQ} = duration of pulse at output Q.

NOTE 8: Load circuits and voltage waveforms are shown in Section 1.



SN54122, SN54123, SN54130, SN74122, SN74123, SN74130 RETRIGGERABLE MONOSTABLE MULTIVIBRATORS

SDLS043 – DECEMBER 1983 – REVISED MARCH 1988

TYPICAL APPLICATION DATA FOR '122, '123, '130

For pulse durations when $C_{ext} \leq 1000$ pF, see Figure 4.

The output pulse duration is primarily a function of the external capacitor and resistor. For $C_{ext} > 1000$ pF, the output pulse duration (t_w) is defined as:

$$t_w = K \cdot R_T \cdot C_{ext} \left(1 + \frac{0.7}{R_T} \right)$$

where

K is 0.32 for '122, 0.28 for '123 and '130

R_T is in $k\Omega$ (internal or external timing resistance.)

C_{ext} is in pF

t_w is in ns

To prevent reverse voltage across C_{ext} , it is recommended that the method shown in Figure 2 be employed when using electrolytic capacitors and in applications utilizing the clear function. In all applications using the diode, the pulse duration is:

$$t_w = K_D \cdot R_T \cdot C_{ext} \left(1 + \frac{0.7}{R_T} \right)$$

K_D is 0.28 for '122, 0.25 for '123 and '130

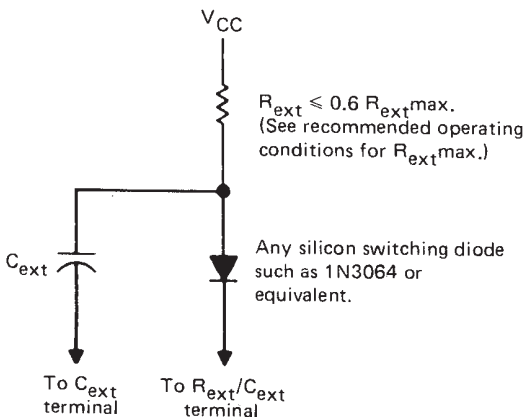

TIMING COMPONENT CONNECTIONS WHEN $C_{ext} > 1000$ pF AND CLEAR IS USED

FIGURE 2

Applications requiring more precise pulse durations (up to 28 seconds) and not requiring the clear feature can best be satisfied with the '121.



TIMING COMPONENT CONNECTIONS
FIGURE 3

TYPICAL OUTPUT PULSE DURATION vs EXTERNAL TIMING CAPACITANCE



FIGURE 4

†These values of resistance exceed the maximum recommended for use over the full temperature range of the SN54' circuits.

SN54LS122, SN54LS123, SN74LS122, SN74LS123 RETRIGGERABLE MONOSTABLE MULTIVIBRATORS

SDLS043 – DECEMBER 1983 – REVISED MARCH 1988

TYPICAL APPLICATION DATA FOR 'LS122, 'LS123

The basic output pulse duration is essentially determined by the values of external capacitance and timing resistance. For pulse durations when $C_{ext} \leq 1000$ pF, use Figure 6, or use Figure 7 where the pulse duration may be defined as:

$$t_w = K \cdot R_T \cdot C_{ext}$$

When $C_{ext} \geq 1 \mu\text{F}$, the output pulse width is defined as:

$$t_w = 0.33 \cdot R_T \cdot C_{ext}$$

For the above two equations, as applicable;

- K is multiplier factor, see Figure 7
- R_T is in $k\Omega$ (internal or external timing resistance)
- C_{ext} is in pF
- t_w is in ns

For maximum noise immunity, system ground should be applied to the C_{ext} node, even though the C_{ext} node is already tied to the ground lead internally. Due to the timing scheme used by the 'LS122 and 'LS123, a switching diode is not required to prevent reverse biasing when using electrolytic capacitors.

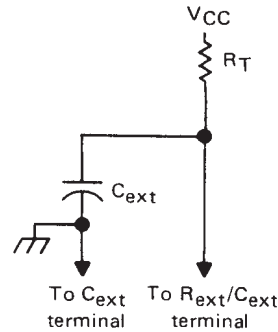

TIMING COMPONENT CONNECTIONS
FIGURE 5

'LS122, 'LS123 TYPICAL OUTPUT PULSE DURATION vs EXTERNAL TIMING CAPACITANCE

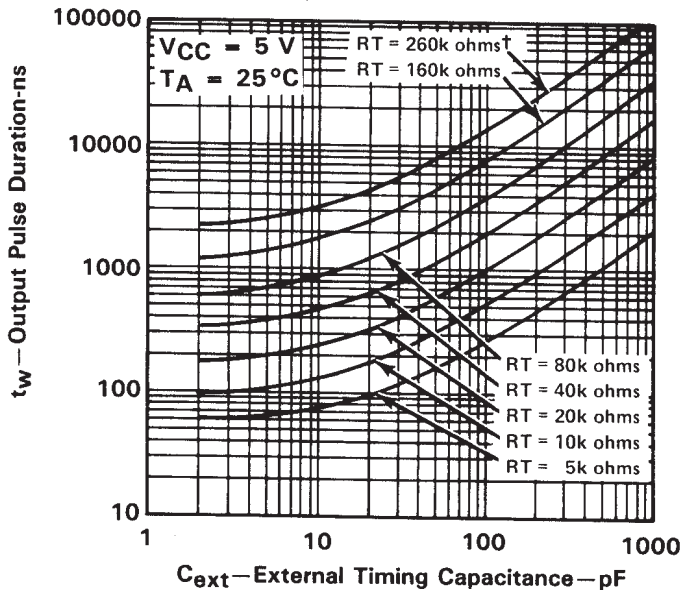

† This value of resistance exceeds the maximum recommended for use over the full temperature range of the SN54LS circuits.

FIGURE 6

SN54LS122, SN54LS123, SN74LS122, SN74LS123 RETRIGGERABLE MONOSTABLE MULTIVIBRATORS

SDLS043 – DECEMBER 1983 – REVISED MARCH 1988

TYPICAL APPLICATION DATA FOR 'LS122, 'LS123†



FIGURE 7



FIGURE 8



FIGURE 9



FIGURE 10

NOTE 14: For the 'LS122, the internal timing resistor, R_{int} was used. For the 'LS122/123, an external timing resistor was used for R_T .
†Data for temperatures below $0^\circ C$ and above $70^\circ C$ and for supply voltages below 4.75 V and above 5.25 V are applicable for SN54LS122 and SN54LS123 only.

IMPORTANT NOTICE

Texas Instruments and its subsidiaries (TI) reserve the right to make changes to their products or to discontinue any product or service without notice, and advise customers to obtain the latest version of relevant information to verify, before placing orders, that information being relied on is current and complete. All products are sold subject to the terms and conditions of sale supplied at the time of order acknowledgment, including those pertaining to warranty, patent infringement, and limitation of liability.

TI warrants performance of its semiconductor products to the specifications applicable at the time of sale in accordance with TI's standard warranty. Testing and other quality control techniques are utilized to the extent TI deems necessary to support this warranty. Specific testing of all parameters of each device is not necessarily performed, except those mandated by government requirements.

Customers are responsible for their applications using TI components.

In order to minimize risks associated with the customer's applications, adequate design and operating safeguards must be provided by the customer to minimize inherent or procedural hazards.

TI assumes no liability for applications assistance or customer product design. TI does not warrant or represent that any license, either express or implied, is granted under any patent right, copyright, mask work right, or other intellectual property right of TI covering or relating to any combination, machine, or process in which such semiconductor products or services might be or are used. TI's publication of information regarding any third party's products or services does not constitute TI's approval, warranty or endorsement thereof.