

*Renewable Ocean Energy Sources: Part
I—Ocean Thermal Energy Conversion*

May 1978

NTIS order #PB-283104

Renewable Ocean Energy Sources

Part I Ocean Thermal Energy Conversion

 CONGRESS OF
THE UNITED STATES
Office of Technology Assessment
WASHINGTON, D. C. 20540

Library of Congress Catalog Card Number 78400053

For sale by the Superintendent of Documents, U.S. Government Printing Office
Washington, D.C. 20402, Stock No. 0524034)0536-1

Foreword

This report on ocean thermal energy conversion is the first part of the Office of Technology Assessment's study of renewable ocean energy sources which are now being considered as possible contributors to the future energy supply of this country. Other ocean energy sources, such as tides, waves, winds, currents, and salinity gradients, will be included in a second part of the study. The complete work, requested by Senator Ernest F. Hollings on behalf of the national Ocean Policy Study of the U.S. Senate, will tell Congress where we are in developing the means to use ocean energy, what problems have been solved, and what difficulties are still to be surmounted. It is hoped that the reports will be useful to decisionmakers in Government and industry for guiding and evaluating research on ocean energy technologies and in making funding decisions or choices among many possible options.

The work undertaken by OTA was confined to an assessment of the technical feasibility and an evaluation of current research and development programs for each possible source of ocean energy. Because the technologies are not yet developed to the point where materials, sizes, sites, and costs can be precisely estimated, OTA found it inappropriate to attempt a detailed environmental or social impact assessment at this time.

This analysis of ocean thermal energy conversion was prepared by the Oceans Program staff of OTA with the assistance of advisors from industry, Government, and academia who provided guidance and reviewed draft materials. A working paper, which provides technical background data used in the analysis, is also being published at this time as a separate document. The remainder of the OTA study of renewable ocean energy sources will be published in late 1978.

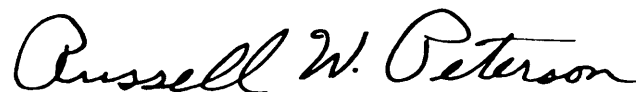

RUSSELL W. PETERSON
Director
Office of Technology Assessment

Renewable Ocean Energy Sources Ad Hoc Advisory Group

Benjamin H. Barnett, Jr.
Merrill, Lynch, Pierce,
Fenner and Smith, Inc.

Don Dunlop
Florida Power and Light Co.

Hal Goodwin
Marine Policy Consultant

Edward Helminski
National Governors Conference

Richards T. Miller
U.S. Navy (Retired)

Willard Pierson, Jr.
CUNY Institute for Marine and
Atmospheric Sciences

Oswald Reels
University of Texas Marine
Sciences Institute

Robert Stein
International Institute for
Environment and Development

Ocean Thermal Energy Conversion Review Panel

A. Douglas Carmichael
Massachusetts Institute of Technology

James A. Finneran
Pullman Kellogg

William Heronemus
University of Massachusetts

James L. Johnson
Standard Oil of Indiana

David Jopling
Florida Power and Light Co.

Richards T. Miller
U.S. Navy (Retired)

Danzil Pauli
National Academy of Engineering

Louis Roddis
Consulting Engineer

Oswald Reels
University of Texas Marine
Sciences Institute

Herman Sheets
University of Rhode Island

Robert Snyder
Oceanographer

Robert Taggart
Marine Consultant

Greg Thomas
Sierra Club

OTA Oceans Program Staff

Robert W. Niblock, *Program Manager*

Bennett L. Silverstein, *Project Director*

Prudence S. Adler
Kathleen A. Beil
Thomas A. Cotton
Renee M. Crawford

Anne Fenn
Emilia L. Govan
Peter A. Johnson
Judith M. Roales

Consultants

Gary Baham
Irvin C. Bupp
Richard C. Raymond
Ralph D. Smalley
Byron J. Washom

OTA Publishing Staff

John C. Holmes, *Publishing Officer*

Kathie S. Boss

Joanne Heming

Contents

<i>Chapter</i>	<i>Page</i>
SUMMARY	1
1. INTRODUCTION	7
An Idea to Fill a Need.	7
The Source of Ocean Thermal Energy	7
The Attractions of Ocean Thermal Energy	7
The Supply of Ocean Energy	8
The Status of Ocean Energy Extraction	10
The Purpose of This Report	11
2. TECHNICAL AND ECONOMIC STATUS	15
Technical Problems	16
Heat Exchangers.	16
Cold Water Pipe.	19
Working Fluid...	20
Ocean Platforms	20
Underwater Transmission Lines	21
Open-Cycle System	22
Construction and Deployment of an OTEC Plant.	23
Reliability of an OTEC Plant	23
Summary of Technical Problems	24
Economic Considerations	24
Electric Power Generation	24
Power for Production of Ammonia.	29
Power for Production of Aluminum	33
Summary of Economic Considerations	34
3. STATUS OF GOVERNMENT FUNDING	39
History of Government funding.	39
Effect of Government Funding on Stat Of OTEC	40
Future Funding Possibilities	42
Summary of Government Funding	44

LIST OF TABLES

<i>Table No.</i>		<i>Page</i>
1.	Countries Bordering Potential OTEC Sites,	9
2.	Power Potential of OTEC Plants at Some Potential Sites.	10
3.	Estimated Capital Costs of an OTEC Electric Generating Plant.	25
4.	Plant Output and Cost per Unit as a Function of Temperature Difference ..	25
5.	Busbar Cost of Electricity	26
6.	Effect of Some Variables on Cost of Busbar OTEC Electricity.	26
7.	OTEC Funding for Fiscal Years 1972 -77	39

LIST OF FIGURES

<i>Figure No.</i>		<i>Page</i>
1.	Potential Marginal Costs of Baseload Electricity in the Year 2000 for Coal or Oil-Fired Powerplants	28
2.	Possible Range of Uncertainty in Future Cost of Busbar Electricity . . .	29
3.	Number of 1,650 Ton per Day OTEC/Ammonia Plants Necessary To Capture Significant Portion of World Plant Capacity.	32
4.	OTEC Program Schedule	41

Summary

Ocean Thermal Energy Conversion (OTEC) is a concept for using the temperature difference that exists between warm waters at the surface of oceans and cold waters in the deep oceans to release stored solar energy to power a turbine.

The number of sites where a sufficient temperature difference exists between the surface and a reasonable ocean depth is limited—there are few off the continental United States—but at these sites the solar energy stored in the ocean is an abundant, renewable source of power. However, harnessing this energy requires complex and potentially expensive equipment of enormous size.

Research on OTEC has been underway since the early 19th century and has been funded by the U.S. Government since 1972. The concept has been touted as one which may be used to provide an important source of energy for the generation of electricity or power for manufacturing energy-intensive products such as ammonia and aluminum.

The Office of Technology Assessment (OTA) Oceans Program, in the course of this assessment, has found that OTEC technology is not yet proven and probably could not become a viable part of the U.S. energy supply system in this century. The concept was demonstrated by Georges Claude on a small scale in 1926, proving that thermal energy can, in fact, be extracted from the temperature difference in the waters of the oceans. But the technology is not developed to the point where acceptably precise estimates can be made about the technical feasibility of large-scale systems, potential products of those systems, the economics of the systems, or the social and environmental impacts.

No scientific breakthroughs are needed to build an OTEC plant, but the technology is not in routine use. Proposed OTEC designs use standard heat-engine cycles which are typical of those used in all powerplants when the heat from burning fuel is converted into electrical power. In conventional powerplants, temperature differences of hundreds or thousands of degrees are sought to get maximum efficiency. An OTEC design will attempt to create useful power from the temperature difference that is usually discarded as unusable in a conventional powerplant.

● *ocean Thermal Energy Conversion*

No OTEC plant has been fully designed; many components of the system have not yet been proven reliable in the hostile marine environment. No ocean energy plant of any size has ever been built and operated which generated more energy than was required to operate the equipment. The technical problems which must be solved are by no means minor, and satisfactory solutions to the critical engineering problems will require long-term laboratory and at-sea testing.

The primary technical problems in the types of OTEC plants currently being proposed involve the heat exchangers, the cold water pipe, the working fluid, the ocean platforms, and the underwater transmission lines from plants which would generate electricity.

Even when a plant is designed and proven, there is little engineering experience which is directly pertinent to the at-sea assembly and mooring problems which may be encountered. And finally, it is not yet possible to project how reliable an OTEC plant would be once it is sited and operating.

The economics of OTEC depend primarily on the capital cost of constructing OTEC plants and the cost per kilowatt hour of the energy produced.

Because no OTEC system is yet fully designed, quantitatively precise knowledge about these costs is impossible and there are large uncertainties about lifetime reliability and the interruptions in production which result should an OTEC plant fail.

The basic product of most current OTEC concepts is power—power for use in the U.S. electric grid or for use in the production of other products. The busbar cost of producing electricity is dependent upon a number of variables, including the thermal resource available, capital cost of the plant, plant capacity factor, fixed annual charge rate, cost of fuel, and the cost of operation and maintenance. Reliable estimates for these variables cannot yet be made. Therefore, it is impossible to predict the busbar cost of electricity from OTEC. Unknown electrical transmission costs add another element of uncertainty.

These still unknown costs will determine whether or not OTEC is useful in the future production of other products.

In the case of ammonia, for example, the most promising market areas are located near the most promising OTEC sites; however, these areas are the Lesser Developed Countries which require very low-cost products. In addition, existing producers are expanding their ammonia facilities to meet present and future demands with existing processes and there are potentially low-cost alternatives to OTEC/ammonia, especially ammonia made from flare gas in the Middle East nations.

For aluminum, world production capacity is currently greater than consumption of the product and little expansion is predicted in the foreseeable future. However, in theory, the use of OTEC could allow aluminum plants to

be located in coastal areas nearer dependable sources of raw materials. In that case, the price and dependability of electricity from OTEC would be crucial factors.

The relative value of OTEC depends heavily on the future price of alternative energy sources. At this time, there is no economically competitive product among those which have been proposed in connection with OTEC. But these economic considerations are based on short-term projections of supply and demand for specific commodities compared with the uncertainties associated with present OTEC technology. The value of developing OTEC technology, however, cannot be measured by simple economic projections because in the long term alternative energy supply options could become much more critical to the United States and to the world. Sometime during the 21st century a renewable source of energy could become a necessity.

Because of the uncertain technical status of OTEC and the lack of conclusive information about its feasibility, there is no obvious amount of funding which should be committed for future research on the concept.

In the long term, decisions about funding are ideally made in the context of an evaluation of the total Department of Energy budget for research on future alternative energy sources. In the absence of such a comparison of alternative energy concepts at this time, Congress could cease to fund a separate research program for OTEC or it could continue to investigate the possibility of OTEC as an ultimately usable technology.

If funding is continued, fairly level research and development money in the tens of millions of dollars for the next 5 to 10 years could result in a program geared toward solving important technical problems. This type of funding would probably result in continuation of many of the present OTEC research projects, but would not result in construction of a large-scale prototype until decisions about type of plants, construction, location, and products could be made in the light of solutions to the major engineering problems.

Large appropriations rapidly amounting to billions of dollars, could influence the program toward development of a working prototype plant as soon as possible. This is a high-risk approach. It could produce the most rapid demonstration of some technology, but it could also result in skipping essential long-term testing and environmental studies. It could also force a premature choice among several concepts and possible products in order to concentrate on development of one specific system.

Chapter 1

Introduction

Introduction

An Idea to Fill a Need

In 1926, Georges Claude announced to the French Academy of Science his intention to develop equipment which would produce “torrents of power” from the difference in temperature between the top and the bottom of the oceans.¹

Claude, the industrial and physical chemist whose work with gases in tubes led to the development of the neon sign, called for immediate action on his ocean energy plan because “the Federal Oil Conservation Board of the United States estimates that the United States has only enough oil to last for 6 years.”²

These dire 1926 predictions ascribed to the Federal Oil Conservation Board did not come true on schedule. But the oil crisis of that period heightened Claude’s interest in extracting energy from the oceans. Now, 50 years later, the United States is faced with an energy crisis, and the dwindling supplies and high prices of fuel have rekindled interest in the oceans.

The Source of Ocean Thermal Energy

The source of ocean thermal energy is the Sun. The oceans act as huge natural collectors, catching and storing solar energy as heat in the surface waters. This stored energy can be extracted by using the heat from the surface waters to evaporate a fluid; passing the resulting vapor through a turbine; and then returning the vapor to liquid state by chilling it with cold water from the deep ocean. The turbine, in turn, can be used to power equipment or to generate electricity. The process is similar to that used in steam powerplants.

¹Daniel Behrman, *The New World of the Oceans*, (Boston: Little Brown and Co., 1969), p. 60.

²*Ibid.*

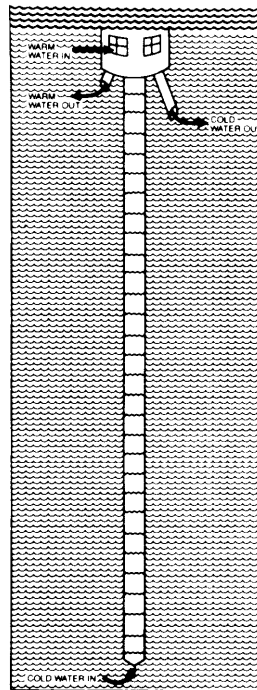

A G@mrk OTEC Plant

The idea of converting the stored ocean energy to useful power originated with French physicist Jacques d’Arsonval in 1881. But in the century since d’Arsonval’s work, the technical feasibility of ocean thermal energy conversion has been demonstrated on only a limited scale. The first plant was built and operated in Mantanzas Bay, Cuba, by d’Arsonval’s pupil, Georges Claude.

Claude’s model plant produced 22 kilowatts of electricity but required about 80 kilowatts of electricity to run its equipment.³ Nevertheless, it was enough to convince scientists and researchers during the subsequent 50 years that the oceans’ stored solar energy could be tapped by using the temperature difference between surface and deep waters.

The Attractions of Ocean Thermal Energy

In the light of the fuel shortages and rising fuel prices of the 1970’s, the attractiveness of **ocean** thermal energy conversion is easy to understand: It offers an almost inexhaustible supply of fuel.

The oceans are massive natural storage basins for solar energy, so that the energy collected is available 24 hours a day. The natural collection and storage capacity of the oceans eliminate

³Georges Claude, “Power from the Tropical Seas,” *Mechanical Engineering* 52 (December 1930): 1039-44.

problems associated with the sporadic availability of energy that marks most other systems for direct use of solar energy.

This around-the-clock availability makes the energy usable for base-load power, that steady stream of power that answers the routine needs of man. Further, of course, the Sun and tropical currents continue to warm the surface ocean waters while polar currents and other factors continue to chill the deep waters. Thus, there is a natural and dependable supply of the fuel—solar energy—and of the temperature difference used in processes for extracting the energy.

These characteristics, coupled with the expectation that use of the stored solar energy will be nonpolluting, make ocean thermal energy conversion attractive.

The Supply of Ocean Energy

There appears to be an abundant supply of this stored energy since the oceans cover more than 70 percent of the Earth's surface. However, the apparent vastness of supply can be misleading since only a very small percentage of the stored energy can be extracted.

There are a number of factors which limit the means of extracting useful ocean thermal energy. Initially, practical OTEC systems need to be located at very favorable sites. Some important site criteria are:

1. High thermal differences between the warm surface and the cold deep water,
2. Low-velocity currents,
3. Absence of storms (minimal wind and waves), and

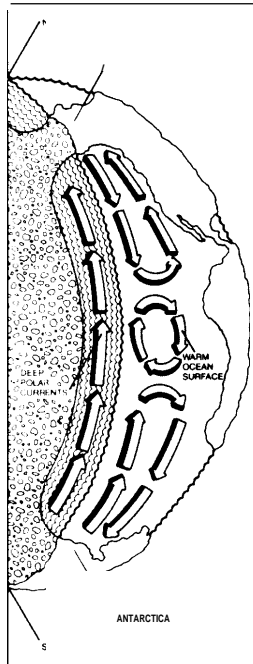

4. Nearness to the market for the OTEC products.

The temperature difference between the surface water and deep water has the most significant bearing on extraction of ocean energy. As the temperature difference decreases the energy output will decrease drastically and the effective cost of each unit of energy will increase.

Current concepts for extracting ocean energy require a temperature difference of 330 to 400 F. With a temperature difference of 30° F, a plant would produce approximately 37 percent less output than with a temperature difference of 40° F. With a temperature difference of less than 300 F, there is a marked loss of power output. For that reason, 300 F can be considered a minimum usable temperature difference to generate net power from a turbine. With a temperature difference of less than 150 F, there may be no net power output at all. That is, all the power produced would be consumed by the plant in running its own equipment and loads.⁴

Even a temperature difference of 40° F presents technical problems. For example, the technology proposed for OTEC designs uses standard heat engine cycles which are typical of those used in all powerplants when the heat from burning fuel is converted into electrical power. In conventional powerplants, temperature differences of hundreds or thousands of degrees are sought to get maximum efficiency. An OTEC design will attempt to create useful power from the temperature difference that is usually discarded as unusable in a conventional powerplant.

This temperature difference requirement means that most potential sites for ocean energy plants are in the tropics because the amount of solar energy absorbed by the surface waters of the ocean is greatest there. The best potential sites for plants to extract ocean energy are located within 20° of latitude north or south of the equator and along the routes of currents which carry warmed waters away from the equator.

There appear to be only two regions off the

⁴ Internal Memorandum to F. E. Naef from M. I. Leitnert Lockheed Missiles and Space Company, "Data for Sig Gronich," Oct. 27, 1977, Sunnyvale, Calif.

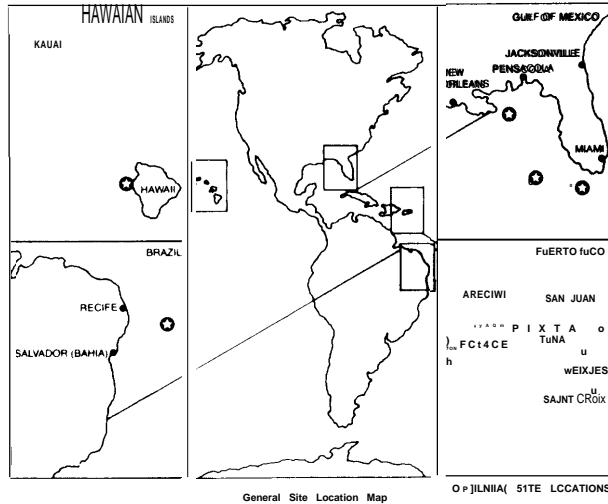

continental United States which are promising sites—the Florida Gulf Stream and the Gulf of Mexico. Other areas of interest to the United States exist off Hawaii, Puerto Rico, the Virgin Islands, Guam, and Micronesia, but at least 37 other countries are closer than the United States to regions of the oceans where there are favorable thermal gradients. Table 1 is one of several available lists which identify countries which are most favorably located relative to potential OTEC sites. An attempt to identify all potential sites worldwide is now underway. Some estimates indicate that an amount of energy equal to about 3 percent of the current U.S. electrical production capacity could be extracted from a 200,000-square-mile section of the Gulf of Mex-

Table 1.—Countries Bordering Potential OTEC Sites
(Minimum distance from coast to suitable OTEC location for countries that border warm tropical waters)

	Distance, km		Distance, km
Countries bordering Indian Ocean (clockwise order):		Countries bordering Atlantic Ocean (clockwise order):	
Madagascar	32	Sierra Leone	50
Mozambique	25	Liberia	50
Tanzania	25	Cote d'Ivoire	50
Kenya	25	Ghana	50
Somali Republic	25	Dahomey	50
Southern Yemen	32	Cameroun	65
Muscat and Oman	6	Brazil:	
Iran	32	1° to 20° South	15
Pakistan	32	Otherwise	100
India:		French Guiana	130
West Coast	120	Surinam	130
East Coast	65	English Guiana	130
Burma	75	Venezuela	3
Countries bordering Pacific Ocean (clockwise order):		Columbia	32
Hawaii	10	Panama	25
Mexico	25	Costa Rica	15
Guatemala	32	Nicaragua	150
El Salvador	65	Honduras	24
Honduras		Mexico	7
Nicaragua		United States of America:	
Costa Rica	7	Florida	1
Panama	25	Puerto Rico	6
Columbia	25	Cuba	2
Ecuador	25	Jamaica	2
Australia:		Haiti	2
Northeast corner	65	Dominican Republic	2
Otherwise	300	Guadelope (French)	2
New Guinea	5	Dominica (British ^b)	5
Java	5	Martinique (French)	2
Philippines	5	St. Lucia (British ^b)	2
Vietnam	75	St. Vincent (British ^b)	2
Sumatra	50	Grenada (British ^b)	2

^aDistance to 5°C water at 500 meters.

^bFreely associated with Britain.

SOURCE: LavL A. "Plumbing the Ocean Depths: A New Source of Power" IEEE Spectrum, 10, 22-27 October 1973.

Table 2.—Power Potential of OTEC Plants at Some Potential Sites

	Area in square nautical miles	Power potential in MWe ^a	Percent of U.S. electric generating capacity ^b	Number of 500 M W OTEC'S required to produce potential power
PAC-I ^c	900,000	69,400	13.0	139
Micronesia.	3,000,000	231,400	43.6	462
ATL-I ^d	360,000	27,800	5.2	53
Gulf of Mexico.	200,000	15,400	2.9	31

a OTEC plant efficiency 1.5 percent; capacity factor = 75 percent.

b electrical generating capacity = 530,000 MWe.

c Physics Lab. study site

140° to 170° Long. East

20° to 30° Lat. North

d Applied physics Lab. study site

400 to 500 West Long.

5° to 15° North Lat.

NOTE: The estimates shown on this table area based upon an assumed gross power production rate of 2 MW/km². 2MW/km² is the additional solar radiation captured at the sea surface due to a temperature depression or anomaly created by the OTEC plant. This is the total thermal input to OTEC, not after conversion by OTEC, assuming that 200 MW/km² is the solar input to the surface. Two preliminary studies made by NRL estimate solar heat flux rate of 4.65 and 1.94 MWe/km² from heat added by solar re-radiation at two different tropical ocean sites. These heat flux rates were estimated on the basis of a 0.1 °C depression in the surface temperature of the water. (Data from *Ocean Thermal Energy Conversion (OTEC), Program Summary*, ERDA, Washington, D. C., October 1976. Also phone conversation with staff members of DOE, Washington, D. C., Jan. 23, 1978.)

In determining the amount of power which potentially could be generated and the number of 500 MW OTEC plants which would be used to generate that much power, the size of the temperature depression deemed acceptable is a critically limiting factor. Since there is currently much uncertainty about the effects of changes in the temperature of ocean waters, this chart uses a very small temperature depression. If a larger temperature depression is allowed, more OTEC plants could be placed in any given area and more-power could be produced

SOURCE: Office of Technology Assessment.

ice⁵ while the equivalent of more than 43 percent of current U.S. electrical production capacity could be extracted from a 3-million-square-mile area in Micronesia. ⁶ However, much of this energy is available at locations far at sea where there is currently no demand for it. In addition, to extract this much energy from these two areas alone would require about 500 ocean energy plants of the 500 MW size.⁷ (See table 2.) Discussions about materials and equipment later in this text will indicate that it is not likely the United States would be able, during at least the next 20 years, to construct the amount

of hardware, much of it larger than any power-plant equipment in existence today, which would be required to extract such large amounts of ocean energy.

A total assessment of the oceans' thermal resources and their relationship to the amount and kind of energy needed in specific places has not been made. However, the ocean energy which might be extracted is diffuse and making use of it will pose difficult technical and economic problems which are discussed later in this report.

The Status of Ocean Energy Extraction

The concept of extracting energy from the oceans has become known in the United States by the acronym OTEC—Ocean Thermal Energy Conversion. Funding of Government research on OTEC began with an \$85,000 budget from

⁵L. C. Trimble, et al., *Ocean Thermal Energy Conversion (OTEC) Power plant Technical and Economic Feasibility Technical Report*, Vol. 1, (Washington, D. C.: Lockheed Missiles and Space Company, Inc., April 1975).

⁶U.S. Congress, Office of Technology Assessment calculations.

⁷Ibid. (A 500 MW plant is half the size of a conventional nuclear powerplant.)

the National Science Foundation's Research Applied to National Needs (NSF-RANN) program in 1972. In 1975, the research was transferred to the Solar Energy Division of the Energy Research and Development Administration (ERDA) which is now a part of the new Department of Energy (DOE).

Through fiscal year 1977, the Federal Government had spent about \$27 million⁸ on OTEC research. The money brought proposals for several concepts to generate electricity for transmission to existing electrical grids onshore or to generate power to be used in the at-sea production of such energy-intensive products as ammonia, aluminum, or hydrogen. In fiscal year 1978, \$35 million is budgeted for OTEC research, most of which will be spent designing, building, and testing component parts of a prototype OTEC plant.

OTEC is still a research and development project. There is, as yet, no working OTEC plant; there is no working pilot model. But

⁸ S. Piacsek, et al., *Recirculation and Thermocline Perturbations from Ocean Thermal Power Plants*, (Washington, D. C.: Naval Research Laboratory, 1976).

research is continuing and requests for funds are growing, aimed at demonstration if the concept during the 1980's.

The Purpose of This Report

The future of OTEC research is now before the U.S. Congress, which must choose what level of support to give by annually appropriating funds for further research and development. Ultimately, Congress may be faced with questions about the regulation and operation of OTEC if it becomes a viable energy system.

To aid Congress in making its decisions, the following sections of this report will detail the current status of OTEC technology with particular attention to areas in which significant problems exist. They will also discuss the economic considerations which are pertinent to an OTEC system and outline economic problems facing some of the products most often suggested for OTEC production. The final sections of the report will deal with the present and possible future Government role in funding OTEC research.

Chapter **2**

Technical and Economic Status

Technical and Economic Status

The scientific feasibility of OTEC was demonstrated on a very limited scale by Georges Claude as early as 1926. Claude's experiences, however, pointed up the need for more advanced ocean engineering technology before success of a large-scale system could be expected.

The United States, with the Division of Solar Technology of the Department of Energy as lead agency, is now attempting to develop the technology and demonstrate the feasibility of OTEC on a scale vastly larger than Claude's work. When developed, OTEC could be used to provide power for the production of such products as electricity, ammonia, aluminum, hydrogen, magnesium, and methanol, or for ocean farming. No scientific breakthrough is necessary in order to use OTEC as a power source for these products. However, there are major engineering development problems which must be solved before OTEC could become an accepted part of any *manufacturing* system.

Many troublesome technical concerns encountered during research stem from a single factor: low thermal efficiency. Thermal efficiency is the percentage of heat which can be converted to useful work. Because the heat used in OTEC must be extracted from a low temperature difference, the resulting efficiency is low. At best only about 7 percent of the heat energy stored in the ocean can be converted into useful energy. In practice, however, OTEC plants are projected to operate with net efficiencies between 1 and 4 percent depending on assumptions made regarding auxiliary power requirements.¹ (By contrast, the thermal efficiency of a

steam plant driven with a nuclear or coal-fired heat source is as high as 42 percent.) An offsetting feature is that no fuel is required for the OTEC cycle. However, the result is that very large quantities of solar-heated surface water and cold deep water are required. For a typical 100 MW OTEC design, which is one-tenth of the size of an existing 1,000 MW nuclear-generating station, 1,000 cubic feet per second of surface water must pass through the evaporator and a like quantity of deep water must pass through the condenser heat exchangers. The combined flow rate of 30,000 cubic feet per second is slightly larger than the average flow at the mouth of the Susquehanna River or more than two and one-half times the flow of the Potomac River at Washington.³

Handling this volume of fluids will require some pieces of equipment, such as pumps, motors, and turbines, which are larger than any now in existence. If OTEC plants are to produce energy economically, great care will be necessary to minimize parasitic losses of energy from friction in pumps, heat exchangers, and other equipment. Equally important, however, the margins for design and/or operating error in OTEC plants will be quite narrow.

Beyond the inherent problem of low efficiency, there are many unresolved engineering problems. The primary concerns involve:

- the heat exchangers,
- the cold water pipe,
- the working fluid,
- ocean platforms,
- underwater transmission lines,
- de-emphasis of the open-cycle system, and
- the constructability and reliability of the entire plant.

Until major problems in these areas have been resolved, it will not be possible to estimate the many economic and environmental factors which will determine OTEC'S commercial prospects.

This study has not looked at the possible environmental impact of OTEC plants because

¹Memorandum to G. L. Dugger from H. L. Olsen, Applied Physics Laboratory, "Efficiency of OTEC Power Plants," July 7, 1976, Laurel, Md.

²S. S. Penner and L. Iccaman, *Energy*, (Reading, Mass.: Addison-Wesley Publishing Co., 1974), p. XXV.

³Phone conversation with staff members of U.S. Geological Survey, Reston, Va., Jan. 30, 1978.

that impact would be tremendously dependent upon specifics which are not yet known, such as the type, size, and number of OTEC plants, the location of the plants, substances used in processes aboard the OTEC plant, and the product produced. However, there are a number of environmental factors which should be considered in depth when more is known about a specific system, such as:

- The size and effects of the reduction in the temperature of surface waters of the ocean at OTEC sites.
- The effects of the working fluid on the ocean environment in the event of a leak.
- Possible pollution caused by chemicals and techniques used in the construction of components of the OTEC plant.
- The effects of changes in the nutrient content of the surface waters caused by upwelling deep ocean waters.
- The effects of increased marine traffic.
- The effects of laying underwater transmission lines if the OTEC were to produce electricity for a grid.

These unknown environmental considerations and the better known technical problems all cause significant economic uncertainties about the cost of useful energy or energy-related commodities which might be produced. In fact, contrary to the impression created by some of the popular literature on OTEC,⁴ this study has found the technical and economic problems to be such that there is no obvious competitive product to be produced by OTEC systems during the coming 10 to 15 years.

Currently, all of the products proposed for OTEC plants (including electricity) are existing commodities. This means that anything produced by OTEC systems will be in competition in world or national markets with identical commodities produced by other means. For this reason, a potential investor in an OTEC system would have to be highly confident that OTEC-produced commodities would be dependable and price-competitive.

⁴One of the most recent examples is John F. Judge, "Ocean Power: Is the U.S. Afraid of It," *Government Executive* (December 1977): 29-32.

When considering costs of the system to produce these products, the fact that OTEC uses seawater as "fuel" and therefore may not be subject to continually rising fuel costs is an attractive aspect. In addition, the cost of site acquisition and the cost of operating OTEC plants, once they are constructed, are projected to be small, and adverse environmental impacts are projected to be minimal.

Even so, these positive factors are not enough to outweigh the assortment of technical problems which are also currently associated with OTEC and are identified throughout this report. But as technical problems relating to OTEC are solved and as more information is gained about the future cost and availability of traditional and alternative sources of energy, OTEC could become more attractive than it currently appears to be.

However, it is difficult to draw conclusions about OTEC or to make comparisons with other energy alternatives until there is a definitive system to evaluate—that is, a specific plant, located at a known site, receiving materials for the production of a certain product, and shipping that product out to consumers.

The following sections of this chapter will discuss the principal technical problems and the economic uncertainties about the cost of usable power from OTEC. They will also discuss some of the economic implications of products which could be manufactured using OTEC as a power source. For each of these products, the existing industry was reviewed; the supply and demand relationships of feedstocks and of finished products were analyzed; and the substitution of OTEC as the power source was evaluated.

TECHNICAL PROBLEMS

Heat Exchangers

Heat exchangers are the most critical component, i.e., largest and most expensive, of the closed-cycle OTEC plants currently being developed. Their function is to evaporate and condense the working fluid using the warm and cold seawater. The capital cost of the heat exchanger is a primary factor in the total cost of

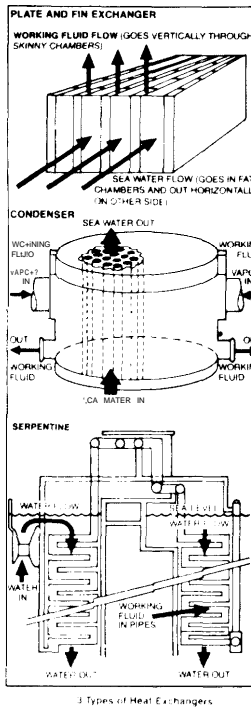

the plant. It has been estimated that approximately one-third to one-half the cost may be assigned to the heat exchanger elements of the system.⁵ Heat transfer effectiveness is also a primary factor in the cost of power generated by an OTEC plant.

Currently the important unresolved development problems for heat exchangers include questions about materials to be used, methods for dealing with biofouling⁶ and corrosion, and the construction techniques which will be necessary.

Materials: Candidate materials which have been considered for OTEC heat exchangers include copper-nickel alloys, fiber-reinforced plastic, stainless steel alloys, titanium, and aluminum alloys.

- Copper-nickel alloys have been the standard material for marine heat exchangers and seawater piping systems for many years. However, while this material is relatively inexpensive and abundant, it is not compatible with ammonia, the principal compound being considered for a

⁵R. H. Douglass, et al., *Ocean Thermal Energy Conversion Research on an Engineering Evaluation and Test Program*, (Redondo Beach, Calif.: TRW Systems Group, February 1975) I-5. Also, L. C. Trimble, et al., *Ocean Thermal Energy Conversion (OTEC) Power Plant Technical and Economic Feasibility Technical Report*, Vol. I, 87-90.

⁶Biofouling—Biofouling is the result of certain marine organisms attaching themselves to submerged objects. Biofouling may be detrimental to the system in a number of ways; it may completely block the flow of seawater in the tubes, it may lead to sharply reduced heat transfer across the tube wall, and it may lead to increased corrosive attack under deposits, i.e., crevice corrosion. It also increases the resistance of the coldwater pipe to currents and to water flowing through the pipe.

working fluid in closed-cycle designs. If the working fluid is Freon, however, copper-nickel is very attractive.

- Fiber-reinforced plastic heat exchangers have been studied for possible OTEC applications, but the feasibility of various proposed composite plastic cores is speculative. Predicted lifetime between replacements has been estimated to be 5 years. Thus, the low initial cost of fiber-reinforced plastic must be balanced with its poor heat transfer rate and the necessity for frequent replacement.
- Titanium has been introduced into marine service in recent years, and two of the major OTEC studies selected titanium as the material for evaporators and condensers because operating experience indicates good resistance to pitting, stress, and intergranular corrosion can be achieved. Titanium is compatible with ammonia and has high strength for its weight. The useful life of titanium heat exchangers has been predicted to be 30 years.⁷

However, there are also problems associated with titanium. It has high susceptibility to biofouling in stagnant seawater, and welding and joining techniques for titanium in very large, complex structures have not been satisfactorily demonstrated.¹⁰

A major problem with titanium is that the high cost and limited supply would prohibit large-scale use of the material in the near future. Titanium is about 3 times as expensive as aluminum, another serious candidate. However, since only some parts of the heat exchanger would be constructed of titanium, the total cost would not be 3 times larger. In addition, life-cycle cost of

⁷A. M. Czikk, *Ocean Thermal Power Plant Heat Exchangers*, (Tonawanda, N. Y.: Union Carbide Corporation, May 21, 1976), p. 100.

¹⁰BM, Corporation, *Systems Description and Engineering Costs for Solar-Related Technologies*, Vol. VII, (McLean, Va.: Mitre Corporation, June 1977), p. 73.

¹¹Ibid.

¹²L. C. Trimble, et al., *Ocean Thermal Energy Conversion (OTEC) Power Plant Technical and Economic Feasibility*, p. S-60.

titanium could prove to be less if components constructed from it are more durable. Presently, the production of titanium is limited. Construction of the heat exchangers for one 100 MWe OTEC plant would require a supply of titanium equal to about one-quarter the total titanium mill products shipped in 1974.¹¹ Although the industry capacity is expected to double by 1985, it would still be inadequate for large-scale production of OTEC plants.

- Stainless steel alloys are similar to titanium in life expectancy and are in better supply. According to the U.S. Bureau of Mines, the peak in stainless steel production came in 1974 at **1,345,000** tons, compared to titanium production of 17,600 tons. ¹²(However, not all that quantity of stainless is of a quality suitable for use in an OTEC.) The unit cost of stainless steel is about **40** percent that of titanium welded tube. However, a greater thickness of stainless steel is required because of the lower strength of stainless; and the resulting total heat exchanger costs would be about equivalent. 13
- Aluminum alloy is also a leading candidate for OTEC plants. The welding and forming techniques for aluminum are far better established than for other candidate materials and the existing production base is much larger. However, the compatibility of aluminum with seawater and ammonia must still be demonstrated.

So far, there is no obvious best material for the heat exchangers. Only design and testing of the heat exchanger over a substantial period of time, in connection with specific water conditions at a given site with known types of biofouling with prescribed cleaning and recleaning techniques and with a known working fluid will

¹¹ Letter to T.A.V. Cassel, Bechtel Corporation, from Stanley L. Hones, Titanium Metals Corp. of America, Irvine, Calif., Dec. 9, 1974.

¹² Extrapolated from U.S. Department of the Interior, Bureau of Mines, *Commodity Data Summaries 1977*, (Washington, D. C.: U.S. Department of the Interior, January 1977), p. 178.

^{13A.} M. Czikk, et al., "Ocean Thermal Power Plant Heat Exchangers," *Sharing the Sun*, A Joint Conference of the International Solar Energy Society and Solar Energy Society of Canada, Inc., Winnipeg, Canada, August 1976.

determine if there is an acceptable material at an acceptable cost. Some testing has begun under the DOE program.

Biofouling: As biofouling builds up, the overall heat transfer is reduced. Net power output and overall plant efficiency are reduced because more power is required to move the heating and cooling water through the system. However, the rate of biofouling of heat exchanger surfaces—which is dependent upon many site-specific factors such as water temperature and nutrient concentration—is only partially known at this time. Periodic cleaning will be necessary to keep the seawater side of the evaporators and condensers free of biofouling. Some means of conducting this cleaning are being studied, but it is not known what effect such cleaning will have on the rate of corrosion and on the life expectancy of equipment. Likewise it is not known how often cleaning will be necessary or the length of time the OTEC plant will be out of operation due to biofouling. Data are just now becoming available from DOE tests which address these problems,

An overall assessment of the impact of biofouling and tube cleaning on the capacity of the plant has not yet been made for any of the OTEC concepts, but tests are underway.

Construction: Several types of heat exchanger designs have been proposed, using tube and shell, with fluted, enhanced, and serpentine surfaces. Plate and fin exchangers are also being designed. Yet the construction of heat exchangers of these designs in the size required for OTEC is not now common practice. The largest heat exchangers constructed to date have had tube surface areas of about **500,000** square feet. A 100 MW OTEC will require 10 times that, or about 5 million square feet of heat exchanger surface area. The surface area will be provided by a number of heat exchangers, ranging in size from 200,000 square feet each to 1.2 million square feet each. It is likely that this increase in size will result in problems which are not encountered in present heat exchanger designs. Also, depending on the material selected for the heat exchanger, there may be problems of welding, forming, and extruding sections.

¹⁴ L. C. Trirnble, et al., *Ocean Thermal Energy conversion (OTEC) Power Plant Technical and Economic Feasibility*.

One engineering company, in response to a query about OTEC, put the construction problem in these terms:

We are dealing with a conceptual design which does not fit within the limits of our present range of experience. We believe that these exchangers can be built, but that the technological and practical problems which would have to be solved would be—in the least—challenging and possibly—in the long run, when considering costs and manufacturing capability—prohibitive. 15

Cold Water Pipe

The purpose of the cold water pipe is to bring cold water from the deep ocean to provide cooling water for the condensers.

The cold water pipe is one of the most significant engineering challenges in OTEC design. Several types and materials have been considered to date. These include structures of steel, aluminum, reinforced concrete, fiber-reinforced plastic, and rubberized materials. All these materials raise questions as to the size of the structures which can be built and deployed at the depths at which they must be used. For example, the largest diameter reinforced-concrete and fiber-reinforced plastic pipes currently used for nuclear powerplant cooling water and sewer effluent outfalls range from 10 to 12 meters in diameter. " Steel pipe outfalls have been built with diameters of about 20 meters. However, a 100 MW OTEC may require a cold water pipe that is more than 40 meters in diameter*7 and more than 800 meters long. The length of the OTEC cold water pipe would be the equivalent of 20 to 30 Baltimore Harbor Tunnel tubes hanging vertically in the deep ocean. 18

Two distinct types of pipeline problems exist: one for stationary plants located on shore and one for floating offshore platforms.

"Ibid.

16 T. R.w., Oceans System Division, December 1976.

"U.S. Congress, House Committee on Science and Technology, Subcommittee on Advanced Energy Technologies and Energy Conservation Research, Development and Demonstration, *FY 1979 Authorization Hearings*, "Statement of Eric H. Willis," U.S. Department of Energy, Jan. 26, 1978.

"Phone conversation with administrator of Baltimore Harbor Tunnel, Feb. 7, 1978.

In a stationary, land-based OTEC plant, the cold water pipe would be anchored to the sea-floor and be designed to conform to the contour along a sloping seabed to considerable depths. The cold water pipe from an OTEC plant will have to reach depths of 300 to 1,500 meters in order to tap the cold water resources which are required for OTEC operation. 19 This is a difficult engineering problem because the pipe might be handled in sections due to the length of the pipeline, which may reach 10 kilometers or more, depending on the bottom contour of the site. The current state-of-the-art for underwater pipelaying is limited to water depths of approximately 150 meters. Small pipes have been laid at greater depths, but there is no experience with large diameter pipes at great depths.

Most recent conceptual designs have utilized floating offshore platforms rather than bottom-mounted platforms or land-based plant sites. In these floating plants, the cold water pipe would be connected to the bottom of the platform. While the floating platforms will require pipes to reach the same depths of water as stationary plants, pipes from the floating plants would be exposed to dynamic loads and stresses which would not be encountered on pipes which are anchored to the bottom. Pipe design and deployment for floating platforms would be difficult. Tried and proven methods for coupling the pipe to the platform, as well as reliable methods for predicting the behavior of the pipe under cyclic loading are not available. Some experience has been gained with Shell Oil's Spar 1 floating oil loading and storage unit in the North Sea. The spar measures 169 meters from its base to the highest point, the height of a 40-story office building, and is anchored in approximately 100-meter water depth. The largest cylindrical section is 29 meters in diameter." Experience from this unit may contribute to the design and deployment of an OTEC plant's cold water pipe.

The pipe cannot be designed without an analysis of subsurface flows of currents at varying depths in specific locations, the effect of oscillations caused by a platform's motions at sea, and

* J. Williams, *Oceanography*, (n.p.: Little, Brown and Co., 1962).

"Spar Connection Brings Brent Field Closer to Production," *Ocean Industry* 11 (August 1976), 45.

the resultant loadings. The effects of biofouling on the inside and outside of the pipe must also be analyzed. In addition, the large amount of drag caused by a large pipe would tremendously increase power requirements if dynamic positioning were used to keep the platform on site.

Working Fluid

The working fluid is a compound which is vaporized in the plant's evaporator by the use of warm seawater, expanded in the turbine where power is extracted, and finally condensed to a liquid by the use of cold seawater. Open-cycle systems use warm surface seawater as the working fluid. The water is vaporized in a vacuum and is not recycled. Closed-cycle plants such as those currently being proposed use a secondary medium as the working fluid and continuously recycle it. Most of the currently proposed closed-cycle OTEC plant concepts use ammonia as the working fluid. Some concepts use Freons and propane.

Ammonia has been chosen for two reasons: 1) the work extracted by the turbine from each pound of ammonia is at least 3 times that extracted from propane and 2) the higher thermal conductivity and heat capacity of ammonia may make it possible to reduce the size of the heat exchanger. There have been no tradeoff studies on complete OTEC systems that clearly determine the appropriate working fluid. Freons and propane may well be superior to ammonia for some applications.

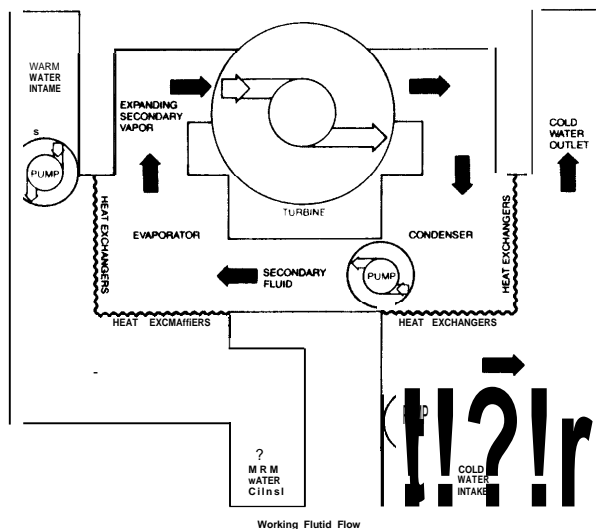

In the event of a spill of the working fluid or a leak from the OTEC plant, ammonia is highly toxic and slightly flammable. Low-level leaks are to be expected, and there could be immediate damage to the environment which has not yet been assessed. But the detrimental effects of ammonia should be less long term than those which might be caused by Freons or propane because ammonia decomposes into compounds which are nutrients. In addition, ammonia can easily be detected because of its odor.

Ammonia will readily dissolve in seawater to form ammonium hydroxide, which may be incompatible with some materials. Therefore, the use of ammonia may limit the selection of materials to those which are compatible and resistant to corrosion, such as titanium and stainless steel alloys.

Thus, selection of working fluid and materials which are compatible and protection of the surrounding environment from leakage are important engineering considerations which affect every facet of plant design and materials selection.

Ocean Platforms

The structures required to house OTEC equipment in the open ocean may be stationary platforms anchored to the seafloor or floating platforms moored or dynamically positioned at a particular site.

To date several configurations have been suggested, including semisubmersible and spar-buoy shapes, ship-like forms, and disk-shaped hulls. It is expected that although OTEC platforms may well be larger than any platform yet designed by the petroleum industry, the designs and accomplishments of that industry will play an important role in development of OTEC structures. A few oil storage and production platforms in the North Sea approximate the size necessary for OTEC platforms exclusive of the cold water pipe, mooring systems, and transmission lines.²¹ Operating experience with even these platforms, however, is as yet very limited.

The major technical problem which must be dealt with in designing the platform is the dif-

²¹Ronald Greer, *Ocean Engineering Capabilities and Requirements for the Offshore Petroleum Industry*, (New York: American Society of Mechanical Engineers, 1976).

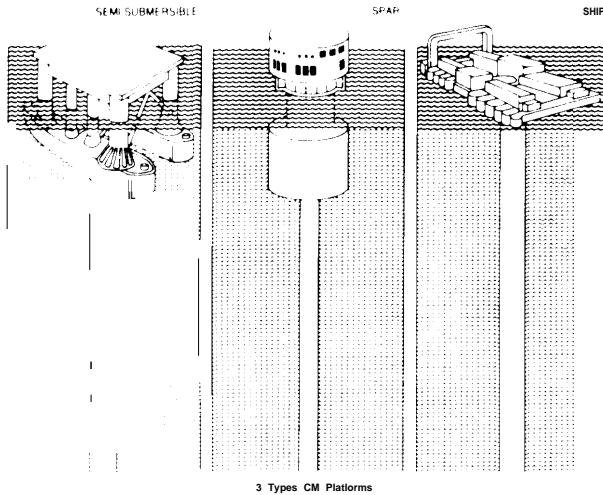

difficult one of connecting a heavy submerged structure (the cold water-pipe) to a surface platform subjected to wave action. Claude's early experiments with much smaller floating structures resulted in failure and lost cold water pipes. Semisubmerged or completely submerged platforms may minimize dynamic action, but the structural dynamics of floating platforms and cold water pipes appear to be a major technical problem.

Another difficult task is keeping the platform onsite in the open ocean which may be subject to high winds, waves, currents, etc. Mooring a platform of the size required for OTEC in very deep waters would be a difficult engineering problem requiring unique designs and materials. Dynamic positioning could be used but may require large amounts of power in even moderate ocean currents. Warm and cold water which must be ejected from the machinery could be used to position the platform.

Underwater Transmission Lines

Dependability of the underwater transmission lines which would be needed to move OTEC-produced electricity to shore would be critical to the success of any OTEC electric powerplant. However, these lines pose a particular problem because of the limited state-of-the-art in submarine cables, Two 250 MW DC power cables have recently been laid across the Norwegian Trench in more than 550 meters of water" and French and British electric companies are considering a 2,000 MW cable across the English

Channel .23 This technology is equivalent to that which would be required for an OTEC plant delivering electricity from a site reasonably close to shore.

The economics of transmitting electricity to shore is greatly affected by the distance which must be covered by cables and the fact that there must be a number of cables taking different routes to shore in order to ensure reliability. With the cost of underwater transmission lines at roughly \$1 million/mile or more,²⁴ at some potential OTEC sites 200 miles from shore in the Gulf of Mexico, the cost of a single cable could equal the capital cost of constructing the OTEC plant. (In coal-fired or nuclear power systems onshore, construction of the transmission cable is roughly 12 percent of the total construction cost .²⁵)

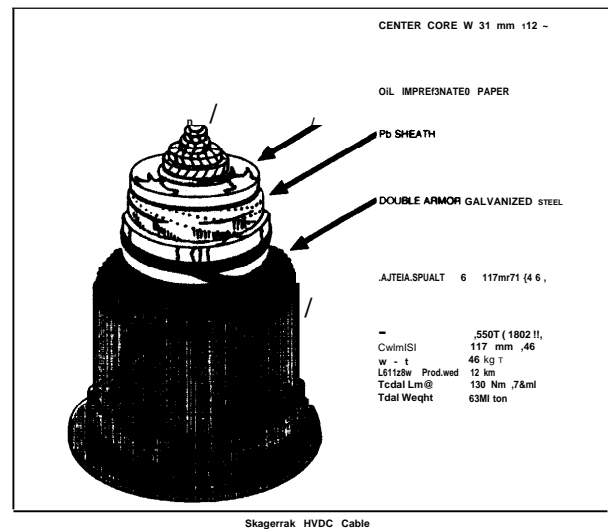

In addition, construction of the electrical cable connecting the OTEC plant to the submarine cable will be difficult. For example, there is no known method of disconnecting and re-connecting the OTEC to the cables if this need arises due to severe winds and waves.

²⁴"Power Cables Cross Norwegian Trench, " *Ocea*] *Industry* 12 (March 1977).

²⁵1bid.

"L. C. Trimble, et al., *Ocean Thermal Energy Conversion (O TEC) Poulter Plant Technical and Economic Feasibility*.

"Edison Electric Institute, *Statistical Yearbook of the Electric Utility Industry for 2975*, (New York: Edison Electric Institute, October 1976), p. 59.

Open-Cycle System

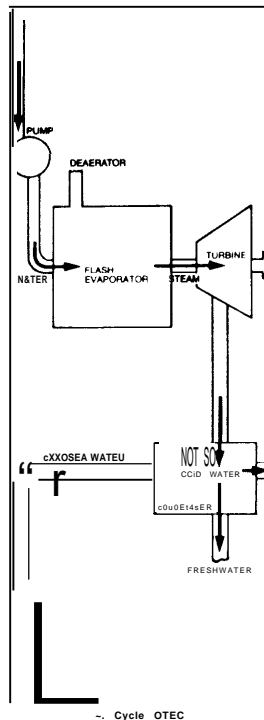

The open-cycle concept, which does not recover the working fluid and reuse it, was basically eliminated from consideration about 8 years ago when research was under the direction of the National Science Foundation. Until recently, ERDA has directed most of its funding toward the closed-cycle concept, in which the working fluid is continuously recycled.

The first important development of the open cycle was accomplished by Georges Claude in the 1920's. Claude reasoned that the major disadvantage to closed-cycle ocean thermal power-

plants is that the evaporator and condenser use about one-half of the temperature difference to get the heat into the working fluid. Thus only half the temperature difference is available for work by the turbine. Claude's assessment of the problem is summarized in the following statement:

Manifestly such a solution is burdened by a number of inconveniences, one of them being the high cost of such evanescent substances (working fluids, i.e., ammonia), and another the necessity of transmitting enormous quantities of heat through the inevitably dirty walls of immense boilers with such a small difference of temperature. ²⁶

The open or "Claude" cycle uses ocean water as the working fluid as well as the heat source. The warm surface water is evaporated in a boiler at very low pressure, in a vacuum of approximately 0.5 psig. The resulting steam is then expanded in a very large diameter turbine. Finally the steam is condensed by either mixing directly with cold water pumped from ocean

²⁶ Georges Claude, "Power from the Tropical Seas," *Mechanical Engineering* 52 (December 1930): 1039.

depths or in a surface-type heat exchanger similar to the closed-cycle type. The latter modification permits production of potable water from the steam condensate.

The use of direct contact heat exchangers in both the evaporator and condenser eliminates the need for enormous heat transfer surface area. Thus the area subject to corrosion and fouling, particularly in the evaporator which is at a higher water temperature, is greatly reduced.

The reason most often given for the choice of a closed-cycle concept is that the open cycle would require a turbine of prohibitive size. For example, a single turbine yielding 100 MWe could be as much as 57 meters in diameter. However, no practical proposal would consider a single turbine. The smaller (3 to 5 MWe) turbines which are more likely to be used are very close to the size of conventional low-pressure steam turbines now in existence. ²⁷ Problems of corrosion and deaeration are also inherent in an open-cycle plant. Noncondensable gases released from feedwater are the greatest source of air in the boiler. The effect of this air is to lower turbine output and to seriously limit the capacity of the condenser, thus, this air must be removed prior to condensation. ²⁸ The use of low-pressure flash distillation chambers and other methods of controlling this problem are being investigated. ²⁹

De-emphasis of the open cycle in current research and development appears to be a questionable decision because the massive heat exchanger required for a closed-cycle OTEC plant may limit the size of each OTEC unit. Open-cycle machinery, particularly small turbines, condensers, and ejectors could be developed along with closed-cycle machinery. Use of the

²⁷ L. Schereschewsky, *Electric Power Generation From the Tropical Sea, Geothermal Water, Wells and Other Sources of Low Temperature Water . . . Modernization of the Claude Process*, (n. p.: United Nations Division of Resources and Transport, August 1972), p. 23.

²⁸ Andr& Nizery, *Utilization of the Thermal Potential of the Sea for the Production of Power and Fresh Water*, (Berkeley, Engineering Research, Sea Water Project, March 1954), p. 5.

²⁹ Donald F. Othmer, "Power, Fresh Water, and Food from the Sea," *Mechanical Engineering* 98 (September 1976): 27.

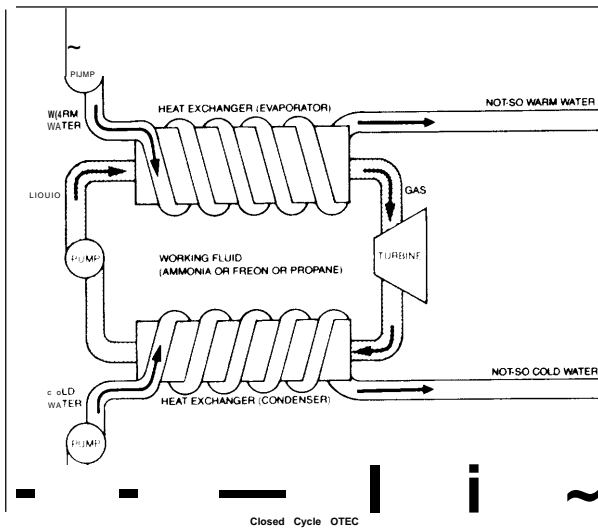

open cycle, which turns out desalinated water as a byproduct of the process, may be especially attractive on some isolated island or in coastal communities.

Construction and Deployment of an OTEC Plant

There are conflicting views about the facility which will be required. One school of thought believes that any large shipbuilding facility could undertake the construction. Another holds that the construction facility itself would be a novel endeavor. Such a construction facility could be a several hundred million dollar investment.

Deployment and mooring of OTEC plants in a potentially hostile environment at sea may also be a problem. There appears to be little engineering experience which is directly pertinent to final onsite assembly of a large OTEC system, although much can be learned from the experience of the petroleum industry in the North Sea and elsewhere. The cold water pipe and undersea electric transmission cables are particularly challenging deployment problems.

Reliability of an OTEC Plant

Once an OTEC plant is actually constructed and sited, it will have to continue to operate reliably for at least 20 years in order to amortize the very large capital investment which will be required. Reliability is often expressed in terms of plant capacity factor. The plant capacity fac-

tor is the ratio of the power actually produced during a given period to the total which a plant operated at constant full power could produce during the same period. Most of the current OTEC plant concepts claim a capacity factor of 90 or 95 percent.³⁰ This appears to be highly optimistic for new technology with no proven record of operation.

The capacity factor will be reduced primarily by scheduled and unscheduled maintenance and repair; seasonal variations in ocean temperatures; variations in ocean currents and wind conditions which may increase the power requirements for operating equipment; and the buildup of biofouling organisms which reduce heat transfer rates and may require that equipment be shutdown for cleaning.

Based on experience with ship machinery, large pieces of equipment operating in the ocean require a periodic overhaul, typically lasting 1 to 3 months, at least once every 2 years.³¹ This gives a capacity loss of approximately 4 to 12 percent. There will also be periods when capacity is reduced due to equipment outages. One OTEC design concept projects one failure lasting 24 hours every 68 days.³² This reduces capacity by another 1.5 percent. In total, scheduled and unscheduled maintenance alone can be expected to reduce the capacity factor below 90 percent. The effects of temperature variations and biofouling will reduce plant capacity still further.

Thus, it appears that an 80- to 85-percent plant capacity factor is the maximum which should be projected for OTEC plants. Even that figure is open to question based on experience with other large energy systems. For example, in the late-1960's many nuclear powerplants were sold with the promise that over their operating lifetime they would realize capacity factors of 80 percent or better.³³ Those expectations are now

³⁰L. C. Trimble, et al., *Ocean Thermal Energy Conversion (OTEC) Powerplant Technical and Economic Feasibility*, p. 2-100,5-21.

³¹Ibid.

UTRW Systems Group, *Ocean Thermal Energy Conversion*, Vol. 3, (Redondo Beach, Calif.: TRW Systems Group, June 1975), pp. 4-15.

³³Irvin C. Bupp, *The Commercial Prospects for OTEC Systems*, unpublished, (Cambridge, Mass.: Harvard University, March 1977).

recognized as having been extremely optimistic. Although there is a wide range of variations in the performance of different types of equipment and there is only a limited amount of information on the most modern plants, it appears that capacity factors in large (greater than 800 MW) nuclear and coal-fired powerplants range from about 50 to 75 percent and are dependent on a wide variety of local circumstances.³⁴ There are some nuclear plants which have achieved 80 percent, but this was only after considerable experience.

Given that record for systems which are much more completely developed and working in a stable and familiar environment, it appears unrealistic to expect that OTEC plants, with many unknowns, would achieve plant capacity factors in excess of 90 percent.

Summary of Technical Problems

No scientific breakthroughs are needed to build an OTEC plant, but the technology for several major components of OTEC is not engineering state-of-the-art. No plant has been fully designed; many components of the system have not yet been developed. The technical problems which must be solved are significant, and satisfactory solutions to the critical engineering problems are likely to require laboratory and at-sea testing. Even when the plant is designed and proven, there is little engineering experience which is directly pertinent to the at-sea assembly and mooring problems which may be encountered. And finally, it is not now possible to project how reliable an OTEC plant will be once it is sited and operating.

NOTE: The OTA Working Paper on Ocean Thermal Energy Conversion, which is being published separately, contains a detailed technical discussion of designs that have been proposed.

ECONOMIC CONSIDERATIONS

Meaningful economic analyses can only be conducted for specific power systems. To date, however, the technical uncertainties of OTEC are so great that only broad economic overviews are sensible, and care should be taken to avoid detailed economic calculations that create a specious aura of accuracy.

³⁴ Ibid.

The following sections provide an overall view of three potential OTEC product systems (electricity, ammonia, and aluminum). Other systems are, of course, possible and may, in fact, prove more useful in the future. However, most Government-sponsored research has focused on these three potential systems. Data are provided on potential markets and on factors influencing the range of costs of OTEC systems.

Electric Power Generation

OTEC plants are first of all powerplants. This power may be fed into an electric utility grid for distribution to customers or it may be used in an energy-intensive manufacturing process which is coupled with the OTEC plant, such as an OTEC/ammonia system or an OTEC/aluminum system.

In any of the foregoing cases, the economics of generating power can be expressed in two types of cost: the capital cost of constructing OTEC plants and the cost per kilowatt hour of energy produced.

Capital Cost of Constructing an OTEC Plant: The conventional method of expressing the cost of building a powerplant is in terms of dollars per net kilowatt of capacity. Existing literature on OTEC reflects an extraordinarily wide range of estimates about the total investment required for the first several plants. The data presented are for different temperature gradients, sizes, and designs of OTEC plants with differing components and equipment and differing learning curves. The capital costs presented range from \$500/kW to \$3,700/kW. These cost estimates are displayed in table 3.

It is even quite possible that the actual costs could exceed this range because all the important variables which will determine the costs are not yet known. For example:

- The choice of material for the heat exchangers may radically affect the cost of construction because the price of candidate materials varies widely;
- The choice of sites will radically affect the cost of construction because the site will influence the type of platform and mooring, the length of the cold water pipe, the dis-

Table 3.—Estimated Capital Costs of an OTEC Electric Generating Plant

	APLa	TRWb	LSMDC	t r e d (Roberts)	M i t r e e
Capital costs in \$/kW.	500-1,000	2,100	2,600-3,700	1,600-1,900	1,600-2,800

a w. H. Avery, et al., *Maritime and Construction Aspects of ocean Thermal Energy Conversion (OTEC) plants*; (Laurel, Md: Applied Physics Laboratory, April 1976), pp. 5-25.

b M i t, corporation, systems *Descriptions and Engineering Costs for Solar Engineering costs for Solar-Related Technologies*, vol. V11.

Cl bid. dlbid. elbid.

tance the product must be transported to shore, and the precautions which must be taken to protect the environment;

- The rate of biofouling may radically affect the cost because fouling reduces the efficiency and thus the output of the plant.

Solutions to these and other technical problems are necessary before rational estimates of OTEC construction costs can be made. In addition, to the capital cost of an OTEC plant must be added the cost of transmission cables to shore. With cable costs at about \$1 million a mile, the transmission lines for a 500 Mw OTEC 100 miles offshore would be about \$200/kW at a switching station on the beach. The need for multiple cables could double or triple this cost.

If OTEC plants could be built at the very optimistic investment cost of about \$500/kW (1976 dollars), OTEC plants would be more attractive than nuclear powerplants built during the mid-1970's³⁶ if the OTEC operating costs were modest.

However, it is prudent to remember that for the past 10 years, engineering estimates of the capital cost of new generating capacity have been persistently low. Early commercial nuclear powerplants actually cost 2 to 3 times more than original estimates indicated they would.³⁷

If the capital cost of an OTEC plant reaches or exceeds the high end of the estimates, \$3,700/kW, construction is less likely to start.

³⁶SL. C. ~rimb)e, et al., *Ocean Thermal Energy Conversion (OTEC) Power Plant Technical and Economic Feasibility*.

³⁷Irvin C. Bupp, et al., "The Economics of Nuclear Power," *Technology Review* 77 (February 1975).

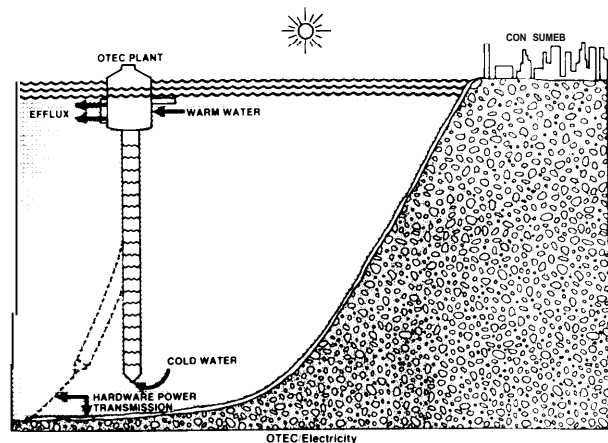

Cost per Kilowatt Hour of Energy Produced: The busbar cost³⁸ of producing electricity by OTEC or any other method is dependent upon a collection of variables. First, the amount of temperature difference has a direct bearing on the net power output of an OTEC plant and the cost of each unit of energy. For example, consider a 100 MW OTEC plant designed for a 400 F temperature difference, with capital costs of \$2,000/kW. If that temperature difference decreases, the plant output would decrease and the cost per unit of output would increase as shown in table 4.

Table 4.—Plant Output and Cost per Unit as a Function of Temperature Difference

Temperature difference ("F)	Plant output (MW)	\$/kW per unit of output
40	100	2,000
30	56	3,500
20	25	8,000
10	6	32,000

Source: Office of Technology Assessment.

³⁸The busbar is an assembly of conductors for collecting electric currents and distributing them to outgoing feeders. Thus, the busbar cost is the cost of electricity before distribution to consumers.

Table 5.—Busbar Cost of Electricity

$$\text{Busbar cost of electricity in mills per kilowatt hour} = \frac{(\text{FCR}) \text{ C/kw} \times 1,000}{(\text{FA}) \text{ T}} + (\text{CF}) + (\text{COM})$$

Busbar cost—cost in mills/kWh at the point of production with no transmission charges (one mill = one-tenth of one cent)

FCFt—fixed charged rate: a percentage figure representing estimates about the long-term costs of debt and equity capital. During the 1960's FCRS of 8 to 10 percent were standard for the American utility industry. During the 1970's, 16 and 17 percent FCRS have been common.

C/kVv—capital investment in dollars per kilowatt as discussed previously in this chapter.

1000-a conversion figure used to convert dollars to mills.

FA—capacity factor: the ratio of the kilowatt hours actually produced during a given period to the total which a plant operated at constant full power could theoretically produce during the same period.

T—total hours in a year: 8,760.

CF—cost of fuel in mills per kilowatt hour: seawater is the equivalent of fuel for OTEC and there is no charge.

COM#—cost of operation and maintenance in mills per kilowatt hour: 4 mills/kWh is an estimate used by proponents of OTEC.

Other variables also affect the per kW cost of electricity produced. The major ones include the capital cost of the plant, the plant capacity factor, the fixed annual charge rate, cost of fuel, and the cost of operation and maintenance.

These costs cannot yet be predicted accurately. If only favorable assumptions are used, the cost of electricity can be made to appear very competitive. If less optimistic assumptions are

used for one or more variables, the cost of electricity rises rapidly. The equation in table 5 demonstrates how the cost changes with these variables.

Some of unknowns in this formula are the fixed charge rate, the plant capacity factor, and the capital investment in construction of the OTEC plant. Table 6 varies these three numbers to show how their uncertainty makes a firm

Table 6.—Effect of Some Variables on Cost of Busbar OTEC Electricity*

Fixed charge rate (FCR)	Capital investment/ kW(C/kW)	Conversion figure	Capacity factor (FA)	Total hours in a year(T)	Cost of operation and fuel in mills/kWh (CF)	cost of maintenance in mills/kWh (COM)**	Busbar cost in mills/kWh
16%	\$600	1,000	95%	8,760	0	4	16
16°/0	\$1,200	1,000	60%	8,760	0	4	41
16%	\$2,400	1,000	600/0	8,760	0	4	77
1670	\$4,000	1,000	800/0	8,760	0	4	95
2070	\$4,000	1,000	800/0	8,760	0	4	118
16%	\$4,000	1,000	600/0	8,760	0	4	126

$$\frac{(\text{FCR}) \text{ C/kW} \times 1,000}{(\text{FA}) \text{ T}} + (\text{CF}) + (\text{COM}) = \text{Busbar cost}$$

- No transmission and distribution costs are included in busbar figures.
- ● Operating and maintenance costs are less predictable than initial investment. They are influenced by the design of capital equipment and are resolved further in the future.

Source: Office of Technology Assessment.

estimate of the final busbar cost of electricity impossible. The first line uses numbers based on a study which produced the lowest of the capital cost/kW estimates shown earlier. Other lines simply use a range of plausible numbers.

Although changes in the variables are rather arbitrarily selected for purposes of this illustration, they do reflect possible values for fixed charge rates, capital investment, and OTEC plant capacity, and they demonstrate how estimates of busbar cost of OTEC electricity can increase by more than 100 mills /kWh.

It is almost as difficult to determine the future cost of power generated by any conventional plant because many unforeseen factors, including political decisions, will determine the construction, fuel, and equipment cost of the future.

Figure 1 displays how increases in the installed costs and fuel costs will affect the cost of electricity from conventional powerplants. For example, a coal-fired powerplant which cost \$400/kW to build and has fuel costs of \$20/ton could produce busbar electricity at about 18 mills/kWh. If the plant cost \$1,000/kW to build and coal was \$60/ton, it would produce busbar electricity at 50 mills /kWh. 39

Since there are as yet unpredictable costs which coal plants will incur to meet air quality regulations, nuclear plants will incur to dispose of radioactive wastes, and so on, it is again difficult to predict future costs. However, projections for conventional powerplants do reflect some years of experience while OTEC projections are strictly rough guesses.

Based on the history of cost escalations for coal and nuclear powerplants and on discussions with personnel who have studied the OTEC concept, figure 2 pictures the difference in the range of uncertainty about the busbar cost of electricity generated in the future. These figures should be read with caution, as they are very general and demonstrate only possible ranges.

So far, this wide range of uncertainty about technical problems and about the cost of electricity from OTEC plants has been a major fac-

tor in discouraging utility company decision-makers from considering OTEC plants for part of their future generating capacity .40

Other Factors: In addition to capital cost and cost per kWh, there are other factors which utilities take into consideration before a decision is made to invest in a particular source of energy or type of facility which would supply electricity to the grid. In order to determine whether public utilities could be expected to provide a major market for electricity generated by OTEC if economics were favorable in the future, OTA has studied the planning process used by utilities and the variables which are analyzed before a decision is made to invest in a particular source of energy or type of facility. Some other major variables considered by the utilities include: ⁴¹

- long-term availability of fuel,
- environmental assessment,
- reserve and reliability of generating capacity,
- construction and licensing time,
- site costs, "
- transmission cost estimates, and
- candidate site selection.

All the variables are not of equal importance in the planning process; however several significant ones show potentially unfavorable aspects of OTEC. Those are: 1) probable lengthy construction and licensing time, based on the difficulty of constructing complex systems in the oceans; 2) high transmission costs, based on expense of undersea cables and distance from shores; and 3) the limited availability of sites near the United States.

Other factors, which show favorable aspects of OTEC, are the possibility that it offers 1) long-term reliability of fuel; 2) low-acquisition costs for offshore sites; and 3) minimal environmental impacts.

However, most public utilities are very conservative when planning new facilities and have indicated to OTA⁴² that they consider only

⁴¹PhO~e conversation between OTA and six coastal area utilities, Feb. 7, 1978.

⁴²B.J. Washom and J. M. Niles, *Incentives for the commercialization of Ocean Thermal Energy Conversion (OTEC)*. (Los Angeles, Calif.: University of Southern California, January 1977), p. 8.

⁴³Office of Technology Assessment staff meeting, Dec. 28, 1976, Washington, D.C.

³⁹Federal Power Commission, *Bureau of Pozoer, Annual Summary of Cost and Quality of Electric Utility Plant Fuels, 1976*, (Washington, D. C.: Federal Power Commission, May 1977).

Figure 1
Potential Marginal Costs of
Baseload Electricity in the Year 2000
for Coal or Oil-Fired Powerplants
Annual Escalation in Installed Cost (above inflation)

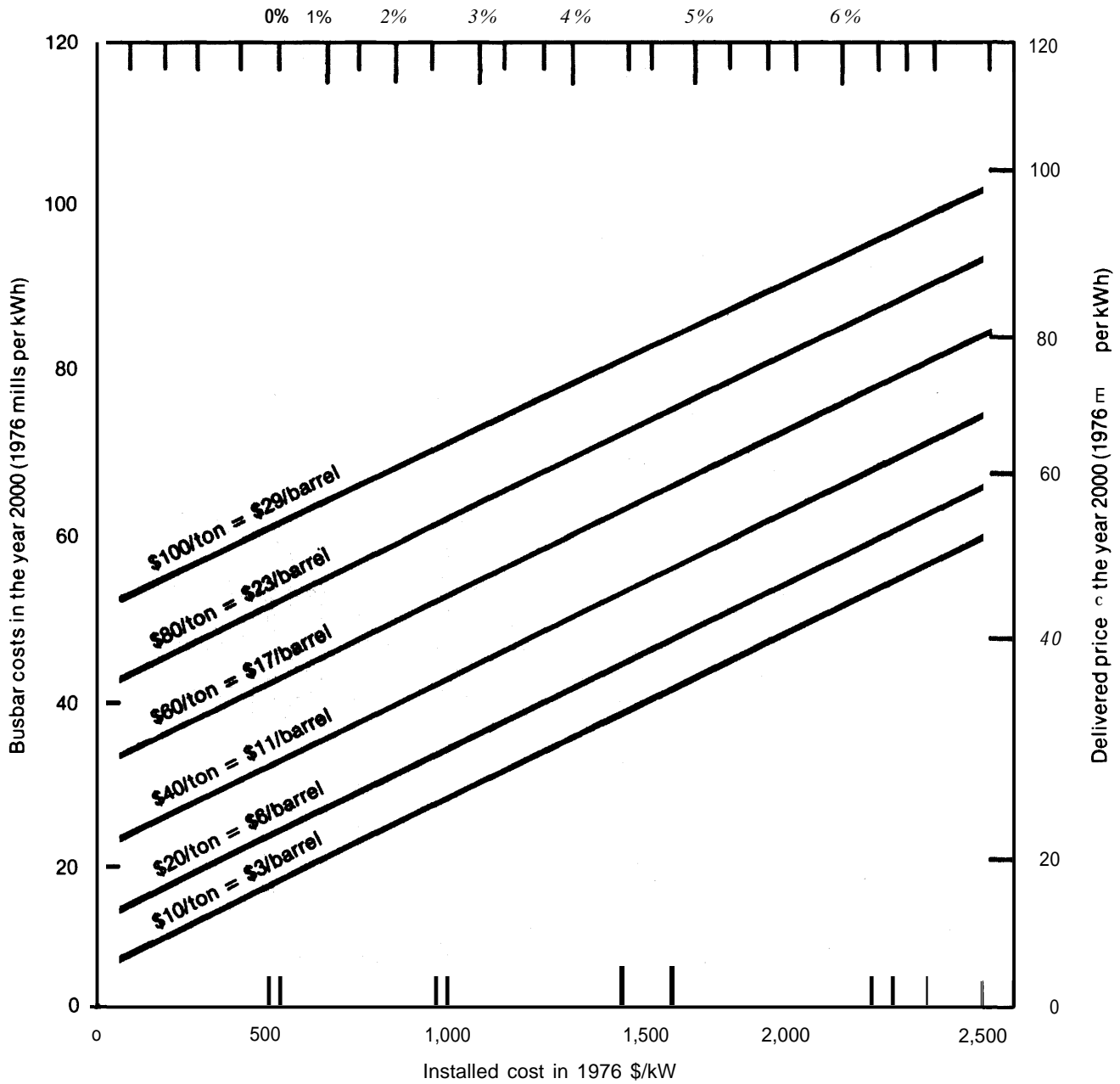

Assumptions:

- 75-percent capacity factor
- 35-percent efficiency in generation and transmission
- Transmission and distribution cost \$300 to \$400/kW
- Operating costs (exclusive of fuel) = \$0.01/kW
- Fixed charge rate = 0.15
- 1976 installed cost \$500/kW

Source: Office of Technology Assessment

Figure 2
Possible Range of Uncertainty in Future Cost of Busbar Electricity

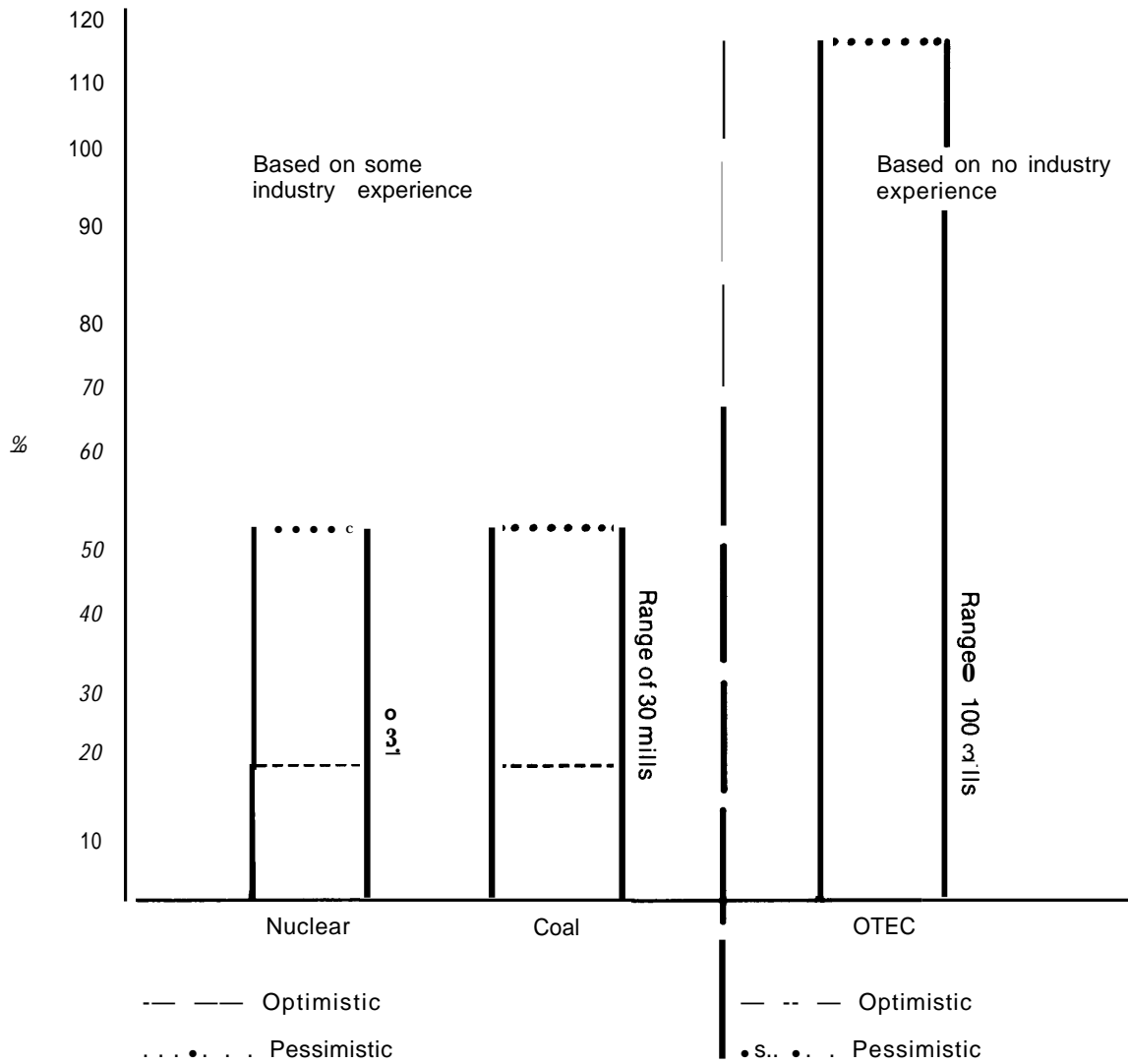

technology which is successfully demonstrated and commercially available when they begin the planning process. The long leadtime required to build and license most facilities requires that the decision to add new capacity generally be made about 10 years in advance of need for the electricity. Therefore, the lack of demonstrated OTEC technology, the lack of dependable estimates for the variables which will be analyzed, and the uncertainties of operating a floating plant in a hostile marine environment ensure that OTEC plants will not be incorporated for

commercial use by electric utilities for many years to come.

Power for Production of Ammonia

The production of anhydrous ammonia (NH₃) has been proposed as an attractive way to use OTEC. Ammonia is used in the manufacture of many chemicals, with about three-fourths of the U.S. production of ammonia being used to make fertilizers for agriculture.

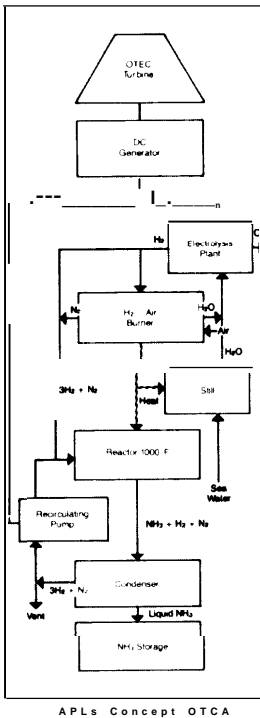

Ammonia is a compound of hydrogen and nitrogen, and presently large amounts of natural gas are used as feedstock in the production of the hydrogen. Approximately 40,000 cubic feet of natural gas is needed to produce 1 ton of ammonia. The ammonia industry used approximately 4 percent of the natural gas consumed in the United States in 1976.⁴³ That figure is expected to rise to more than 5 percent of the natural gas consumption by 1980 and to more than 11 percent by 1990.⁴⁴

If hydrogen could be produced at an OTEC plant by electrolysis of seawater, the natural gas now used as a feedstock could be eliminated. The hydrogen produced aboard an OTEC and nitrogen from the air could be fed to a ship-board commercial synthesizer, and the resulting ammonia could be transferred to shuttle carriers for delivery to consumers.

It is the savings in natural gas which makes the OTEC/ammonia concept attractive. The variables which influence private industry decisions about ammonia production are:

- expected supply and demand
- alternatives to existing processes and/or OTEC, and
- economic competitiveness of OTEC.

Expected Supply and Demand: World demand for ammonia is expected to grow during the next 15 to 20 years at an average annual rate of about 3 to 5 percent. Domestic demand is ex-

⁴³ B. J. Washom and J. M. Niles, *Incentives for the commercialization of Ocean Thermal Energy Conversion Technology (OTEC)*, p.8.

⁴⁴ Irvin C. Bupp, *The Commercial Prospects for OTEC Systems*, p.8.

pected to grow at a slightly higher rate of 5 to 6 percent.⁴⁵

Demand for nitrogenous fertilizer, the largest single user of ammonia, is also expected to grow. The U.S. Fertilizer Institute projects annual growth of about 5 percent in demand through at least the 1980's.⁴⁶ World demand is expected to grow at about 6.5 percent per year due to the increasing use of fertilizers in the Lesser Developed Countries.⁴⁷ Demand in the Lesser Developed Countries, which accounted for 19 percent of the world's nitrogenous fertilizer use in 1975/76, is expected to increase by 89 percent between 1975/76 and 1981/82.⁴⁸ These countries will then account for nearly a quarter of the world's use of nitrogenous fertilizers.

It is clear, then, that fertilizer demand in the Lesser Developed Countries is of interest to ammonia producers. The demand is also particularly meaningful for OTEC/ammonia plants since many of the Lesser Developed Countries have easy access to areas of the oceans where there is a significant thermal resource which could be used in producing power by OTEC. However, the United Nations Food and Agriculture Organization projects that by 1982 the Lesser Developed Countries will have increased their ammonia production capacity by 151 percent, giving them control over 20 percent of the world's nitrogenous fertilizer production⁴⁹ and exerting downward pressure on world prices.

In the United States, the domestic ammonia production capacity is expected to increase about 15 percent by 1980 as plants currently under construction come on stream. Although the United States has been a net importer of ammonia since 1973, during the 1980's and 1990's domestic production capacity is expected to keep pace with consumption needs.⁵⁰

Meanwhile, world production capacity will also continue to grow. The World Bank is

⁴⁵Ibid.

⁴⁶ Edwin Wheeler, president of Fertilizer Institute, speech at the Institute's fall 1977 conference, New Orleans, La.

⁴⁷ U.S. Department of Agriculture, Economic Research Service, 1978 *Fertilizer Situation*, (Washington, D. C.: U.S. Department of Agriculture, December 1977) p. 19.

⁴⁸Ibid.

⁴⁹Ibid.

⁵⁰Ibid.

presently financing a number of ammonia production projects. The Soviet Union and China are expanding their ammonia production capacity, Saudi Arabia, Iran, and Kuwait are constructing large facilities to produce ammonia and petro-chemicals from natural gas which is now being flared.⁵¹ It is clear that by the mid-1980's, the Middle East may be a major source of inexpensive ammonia supplies. In all, world consumption of ammonia is expected to increase 47 percent by 1982, reaching 82 million metric tons.⁵² However, considering the current state of the technology, it is unlikely that OTEC/-ammonia plants could be a part of that massive growth.

Alternatives to Existing Processes and/or OTEC Plants: As stated earlier in this report, natural gas is critical to the current methods of producing ammonia. Although ammonia producers currently benefit from a high-priority rating in the allocation of scarce natural gas, curtailments have occurred in the past and will undoubtedly occur in the future. However, the ammonia plant expansions now underway appear to indicate that the domestic industry is confident that existing technology and known natural gas reserves will support ammonia production at least into the 1990's.⁵³ Industry sources say they feel there is not sufficient threat to traditional ammonia production to justify major capital investment in an unproven technology, such as OTEC, for at least the next 15 to 20 years.⁵⁴

Therefore, for the near term at least, the primary alternative to OTEC/ammonia plants is the traditional production system.

In addition, industry-sponsored studies have shown that coal and fuel oil can be used to replace natural gas as both a fuel and a feedstock in existing or planned ammonia plants.

About 60 percent of the natural gas used in a typical ammonia plant is for feedstock while the

remaining 40 percent is used as fuel.⁵⁵ Conversion of the system to be fueled by oil rather than natural gas is a straightforward, conical operation which can be accomplished during normal maintenance downtime and does not significantly increase the cost of the ammonia beyond that resulting from any change in fuel Price.⁵⁶ It is, however, somewhat more difficult to convert to oil as a feedstock. Such a conversion at existing plants would take 2 to 3 years, including a 6-month to 1-year downtime. As a result, the cost of ammonia would go up at least 25 percent for the more expensive oil feedstock. The cost of the downtime and the cost of converting equipment would raise the price of ammonia still more.⁵⁷ Converting the system to use coal as a feedstock would result in even higher prices.

For the near term, imported liquefied natural gas and domestic synthetic gas are also cited as possible alternative feedstocks.

From the perspective of the U.S. ammonia industry, the most important fact about near-term ammonia production is the certainty of growing competition from low-cost foreign products,

Among the most likely competitors are the Middle East nations, particularly Kuwait and Iran, which appear likely to put large supplies of ammonia on the market as a result of production using natural gas which is currently flared. Although transportation costs may prevent Middle East ammonia from making any major impact in the European and North American markets, the Middle East would have a cost advantage in supplying Lesser Developed Countries. In the domestic market, competition from Middle East ammonia could be countered with tariffs on imported products, however, it is likely that any effort to impose such charges would meet with strong opposition from agricultural users.

⁵⁵ L. J. Buividas, J. A. Finneran, and O. J. Quartulli, "Alternate Ammonia Feedstocks," American Institute of Chemical Engineers, 78th *National Meeting*, Salt Lake City, Utah, Aug. 19, 1974.

⁵⁶ "Allied Solves a Burning Problem, New System Vaporizes Oil, Permits It to be Burned in Furnaces Equipped with Gas Burners Systems Also Works in Gas Turbines," *Chemical Week* (June 8, 1977), p. 35.

⁵⁷ "Private communication between OTA and J. A. Finneran, Pullman-Kellogg Co., July 1977.

⁵¹ Ibid.

⁵² Ibid.

⁵³ Irvin C. Bupp, *The Commercial Prospects for OTEC Systems*, p.9.

⁵⁴ Ibid., p. 10.

Economic Competitiveness of OTEC/Ammonia Plants: One key to the competitive success of OTEC will be the capital cost of a commercial OTEC plant. While the ammonia production component is expected to cost roughly the same as a traditional onshore ammonia plant, the OTEC generating component would be an expensive addition to the capital outlay.

Figure 3 indicates that a large fleet of OTEC/ammonia plants would be necessary in order to capture a significant portion of the world ammonia production capacity. This would mean an investment of billions of dollars in an unproven technology which would have to compete with existing plants.

In addition, existing and planned traditional ammonia plants will not be fully amortized until early in the next century. From a business point of view, this is a crucial consideration because unamortized capacity would not be shut down unless ammonia from an OTEC facility were certain to be considerably cheaper than ammonia from existing plants. Such a guaranteed low cost is extremely unlikely for any novel pro-

duction system, especially one with the technical and operational uncertainties which are associated with OTEC.

Fluctuations in world ammonia prices—caused at least in part by the price and availability of natural gas and the price and availability of foreign ammonia products—would also be a major factor in the ability of OTEC/ammonia plants to compete in the world market.

If an OTEC plant could be constructed for the lowest cost estimates discussed earlier, i.e., \$500/kW,⁵⁸ and if the price of ammonia were \$180/ton, as suggested by the World Bank,⁵⁹ the before tax return on equity for capital investment of \$367 million could be 16.5 percent. Such a return does compare favorably with industry standards. But if the price of ammonia is reduced, the consequences for the return on

⁵⁸W. H. Avery, et al., *Maritime and Construction Aspects of Ocean Thermal Energy Conversion (OTEC) Plant Ships*, pp. 5-25.

⁵⁹Graham F. Donaldson, "Fertilizer Issues in the 1970's and Beyond," *Development Digest XII*, (October 1975):5.

Figure 3
Number of 1,650 Ton per Day OTEC/Ammonia Plants Necessary To Capture Significant Portion of World Plant Capacity

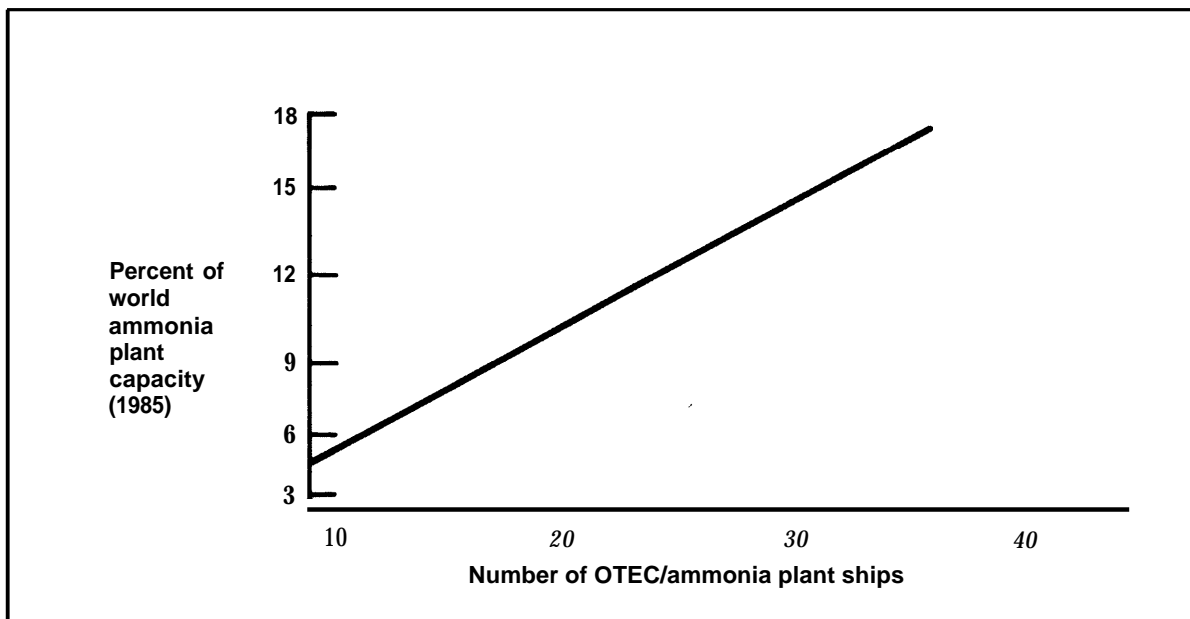

Source: Extrapolated from estimates by the Fertilizer Institute.

equity would be severe. For example, at \$120/ton, the return on equity would be about 7 percent.” At the 1978 price of about \$100/ton, the return on equity would be less than 3 percent. Consequently, ammonia production elsewhere in the world and the balance of supply and demand would be critical to the competitive success of OTEC even with the most favorable assumptions about construction, operating costs, and reliability. As noted earlier, reliable estimates of construction and operating costs cannot yet be made, and there is no experience on which to judge the operational reliability of OTEC plants.

Due to the technical and economic uncertainties discussed in this chapter, it is unlikely that OTEC production of ammonia would be a viable business in the next 10 to 20 years. However, fertilizer for food production may become a critical commodity in the next century when fossil fuels become very scarce. Therefore, the possibility that OTEC could produce ammonia for fertilizer is one incentive for developing and proving or disproving this technology.

Power for Production of Aluminum

OTEC plants have been proposed as the source of power for the electricity-intensive aluminum production industry. The rationale is that offshore OTEC plants could provide electrical power to onshore production plants in regions which have a large supply of the raw material, bauxite, but lack the necessary access to inexpensive power.

There appear to be several major factors which influence whether or not OTEC would be accepted into the aluminum industry:

- the cost and reliability of the power supply,
- the need for a constant, dependable supply of raw materials, and
- the supply/demand picture combined with current low prices and rising costs in the aluminum industry.

⁶¹Byron J. Washom, “Economic Evaluation of Three Commercial Applications for Ocean Thermal Energy Conversion,” unpublished.

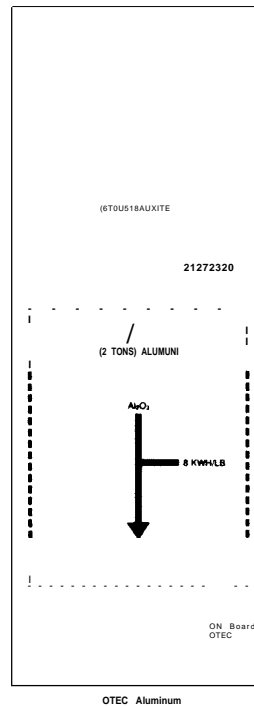

Cost and Reliability of Power: Aluminum production is a two-stage process: bauxite is refined into alumina; alumina is then reduced to aluminum. The alumina reduction stage is the most intensive user of electricity, consuming an average of 8 kWh of electricity to produce a pound of aluminum.⁶¹ The estimated total cost of producing a pound of aluminum in 1976 was 44.7 cents.⁶² By comparison, the cost of the electricity alone for producing a pound of aluminum could range from 12 cents to 96 cents if OTEC costs from table 6

were considered. There are some efforts under way to reduce the kWh/lb ratio,⁶³ however, it is clear that the cost of electricity is a major factor in the profitability of aluminum production. Further increases in the cost of fuel used in other types of electric-generating facilities will reduce the cost differential; however—as discussed earlier—it is impossible to predict what the costs of either conventional or OTEC electricity will be.

Profitability could also hinge on reliable operation of the OTEC plant. As discussed in the section on technical problems, there is currently no experience on which to base estimates of the reliability of OTEC plants. However, experience with large nuclear and coal-fired powerplants has shown that these units operate at only 50 to 75 percent capacity.⁶⁴ Most cost estimates for OTEC plants have been based on estimates of operation at 90 to 95 percent capacity, which, as mentioned earlier, is highly

⁶¹U.S. Department of Commerce, *U.S. Industrial Outlook*, (Washington, D. C.: U.S. Department of Commerce, 1976), p. 60.

⁶²U.S. Department of the Interior, Bureau of Mines, *Commodity Data Summaries*, 1977, (Washington, D. C.: U.S. Department of the Interior, 1977), p. 5.

⁶³U. S. Department of Commerce, *U.S. Industrial Outlook*, 1976, p. 60.

⁶⁴Irvin C. Bupp, et al., “The Economics of Nuclear Power.”

unlikely for a new technology operating in a hostile marine environment.

In addition, the industry will be skeptical of siting new aluminum plants where they depend solely on OTEC as a power source. Traditionally, plants are located where they can be interconnected to a major utility power grid and thus have alternate sources of power. A large-scale demonstration of the dependability of OTEC and a backup supply of power will probably be necessary before industry is seriously interested.

Supply of Raw Materials: The raw material for aluminum production is bauxite, one of the most common ores in the world. However, differences in grades and qualities of ores are sufficient to make supplies from some areas much more economical than others. The major producers of bauxite are Australia, Jamaica, Surinam, Guyana, Guinea, India, Indonesia, Dominican Republic, Malaysia, Haiti, Brazil, and Ghana. Three tons of bauxite are required to produce one ton of alumina, and this reduction generally is accomplished near the source of the raw material. Alumina is then shipped to aluminum manufacturers. Fifty-seven percent of the alumina consumed in the United States comes from Australia. Presently, this amount of alumina, at twice the weight of the finished product, is shipped 11,000 miles to manufacturing sites near cheap hydroelectric power in the United States. It appears likely that the industry would be interested in OTEC plants at the source of the alumina only if the cost of producing OTEC electricity and shipping lightweight aluminum was less than shipping alumina to cheap power sites.

Supply/Demand, Cost, and Prices: U.S. demand for aluminum primary metal in 1975 was approximately 5.1 million tons. The aluminum industry estimates growth at a rate of 8 percent per year during the next 10 years, reaching a total demand of 11 million tons by 1985.⁶⁵

Presently, there is no problem in meeting the demand. Until at least 1974, there was an oversupply of aluminum due to the Government's reduction of its strategic stockpile of aluminum. Through the early 1970's, the stockpile provided about 10 percent of the annual supply. As of

⁶⁵U.S. Department of Commerce, *U. S. Industrial Outlook*, p. 67.

1975, U.S. capacity was approximately 5 million tons. World capacity was 14.5 million tons.⁶⁶

The oversupply and a general economic slowdown left many companies with idle plants or marginal operations as late as 1976, leading analysts to predict only nominal growth in capacity in the foreseeable future.

In addition to the problems caused by oversupply, the aluminum industry has faced rising production costs brought on by increased cost of raw materials, electricity, transportation, and labor. As a result, the nominal purchase price of a pound of aluminum ingot has risen from 39 cents in 1974 to 48 cents in 1976.⁶⁷

As a result of these uncertain costs in an OTEC/aluminum system and the ability of supply to meet demand, at least in the near term, OTEC is unlikely to be an attractive source of power for the aluminum industry.

Summary of Economic Considerations

The economics of OTEC depend primarily on the capital cost of constructing OTEC plants and the cost per kilowatt hour of the energy produced.

Because no OTEC system is yet fully designed, quantitatively precise knowledge about these costs is impossible and there are large uncertainties about lifetime reliability and the interruptions in production which result should an OTEC plant fail.

The basic product of most current OTEC concepts is power—power for use in the U.S. electric grid or for use in the production of other products. The busbar cost of producing electricity is dependent upon a collection of variables, including the thermal resource available, capital cost of the plant, plant capacity factor, fixed annual charge rate, cost of fuel, and the cost of operation and maintenance. Reliable estimates for these variables cannot yet be made. Therefore, it is impossible to predict the busbar cost of electricity from OTEC. Unknown

⁶⁶U.S. Department of the Interior, Bureau of Mines, *Mineral Facts and Problems*, (Washington, D. C.: U.S. Department of the Interior, Dec. 9, 1975).

⁶⁷U.S. Department of the Interior, Bureau of Mines, *Commodity Data Summaries*, 1977, p. 5.

electrical transmission costs add another element of uncertainty.

These still unknown costs will determine whether or not OTEC is useful in the future production of other products.

For ammonia, for example, the most promising market areas are located near the most promising OTEC sites; however, these areas are the Lesser Developed Countries which will require very low-cost products. In addition, already existing producers are expanding their ammonia facilities to meet present and future demands with existing processes and there are potentially low-cost alternatives to OTEC/ammonia, especially ammonia made from flare gas in the Middle East nations. For aluminum, world production capacity is currently greater than consumption of the product and little expansion is

predicted in the foreseeable future. However, in theory, the use of OTEC could allow aluminum plants to be located in coastal areas nearer dependable sources of raw materials. In that case, the price and dependability of electricity from OTEC would be crucial factors.

At this time, there is no economically competitive product among those which have been proposed in connection with OTEC. These economic considerations are based on short-term projections of supply and demand for some specific commodities compared with the uncertainties associated with present OTEC technology. In the long term, however, alternative energy supply options could become much more critical to the United States and to the world, and the value of developing OTEC technology, if successful, cannot be measured by simple economic projections.

Chapter **3**

Status of Government Funding

Status of Government Funding

History of Government Funding

The National Science Foundation (NSF) began funding OTEC research in 1972 when its Research Applied to National Needs program funded **\$85,000** worth of OTEC systems studies

and workshops. In 1975, the Energy Research and Development Administration (ERDA) became the lead agency in OTEC research with an initial budget of about **\$3** million for a variety of tasks on energy utilization, environmental impacts, heat exchangers, and biofouling and corrosion. By 1977, total funding had risen to \$14.5 million in ERDA.¹ OTEC funding for 1972 through 1977 is detailed in table 7.

Concept designs have been developed by Lockheed Missiles and Space Company, TRW Systems Inc., and Johns Hopkins University Applied Physics Laboratory.

Government agencies other than NSF and ERDA have also made modest expenditures for researching OTEC concepts, including the Mari-

¹Energy Research and Development Administration, **Ocean** Thermal Energy Conversion (OTEC) *Programs Summary*, October 1976, and phone conversation with staff member of ERDA, Washington, D. C., Jan. 23, 1978.

**Table 7.—OTEC Funding for Fiscal Years 1972-77
(Budgetary Obligations in Thousands of Dollars: ERDA and NSF combined)**

Program activity	Fiscal year					
	1972	1973	1974	1975	1976*	1977
Program support.				111	2,062	2,381
Definition and systems planning						
—Systems studies and workshops.	85	230	530	786	237	1,440
—Test program requirements.					1,091	328
—Mission analysis.					360	10
—Energy utilization				360	202	136
—Marine environment					312	77
—Environment impacts.				200	457	33
—Thermal resource assessment and siting studies			50	172		
—Legal and institutional studies.				61	145	
Engineering development						
—Heat exchangers.					250	1,721
—Electric cables						200
Advanced research and technology						
—Heat exchangers.			150	435	1,669	2,834
—Exploratory power cables				27		118
—Submarine electrical cables				50		
—Biofouling and corrosion.				207	1,303	2,702
—Ocean engineering.				505	497	25
Engineering test and evaluation						1,498
TOTALS	85	230	730	2,955	8,585*	13,500

*Includes funding for Transition Period (July 1, 1976 to Sept. 30, 1976).

Source: Department of Energy.

time Administration and the Office of Sea Grant (both agencies of the Department of Commerce); the Federal Energy Administration; and the Department of the Navy.

In fiscal year 1978, \$36 million is budgeted for OTEC research by the Department of Energy (DOE). The program includes study of biofouling and corrosion rates and cleaning methods, design and testing of heat exchangers, design of cold water pipe and mooring systems, evaluation of platform shapes, and planning for a pilot plant.²The 1978 OTEC program schedule (figure 4) sets a target of 1982 for having a 5 MW OTEC plant at sea for tests.

ERDA's choice as the primary OTEC mission had been to develop electrical power generation for transmission to the United States or a U.S. territory by underwater cable from an offshore OTEC plant.³With the 1978 funding, however, DOE was ordered by Congress to also pursue development of an OTEC plant ship to manufacture a product such as ammonia, but other possible applications of OTEC, such as desalination, air-conditioning, and cooling of conventional or nuclear powerplants, are receiving little, if any, attention at DOE. In addition, current research is geared toward large-scale OTEC plants, and there is apparently little effort to determine if OTEC plants in the 1 to 5 MW size might have more commercial value than larger plants.

Effect of Government Funding on Status of OTEC

None of the research to date has concluded that an OTEC plant cannot be made to operate. However, the technology for the plants has not yet been proven and many of the components which will be required are considerably larger than similar equipment now in use or otherwise pose difficult design, construction, or development problems.

No OTEC plant has been completely designed and there are critical technical problems. Until

²Meeting with ERDA staff, Washington, D. C., Sept. 28, 1977.

³Letter to W. H. Avery from H. R. Blieden, ERDA, Washington, D. C., Nov. 17, 1976.

these problems are resolved, it is premature to think firm estimates can be made about the cost of OTEC power or the potential uses of OTEC plants.

Conclusions about the technical and economic success or failure and the environmental impact of OTEC plants should be based on consideration of specific OTEC devices at specific sites, manufacturing and marketing specific products, and transporting raw materials into the device and products out to the users. OTEC has not yet been developed to the level where such an assessment is meaningful.

In the past, many claims for OTEC'S value have been too optimistic for the state of OTEC development. Such claims have assumed quick and economic solutions to all the many technical problems which exist. They have assumed market conditions which make OTEC financially attractive. Thus, it is not difficult to deflate the claims simply by making less optimistic assumptions about the timing and cost of solutions to technical problems or by using less optimistic assumptions to assess the market situation in which OTEC will compete. In addition, private investors and industry are currently unwilling to risk their capital on building OTEC plants, and such reluctance on the part of industries which stand to benefit from OTEC is an argument against over-enthusiastic claims.

It is possible that with sufficient time, money, and effort OTEC could be in the national interest. However, as with many new technologies which offer hope of contributing to the solution of some pressing national problem, the needed time, money, and effort will have to be supplied by the U.S. Government until private industry is convinced OTEC is an economically attractive venture.

It is still too early to estimate when—or even if —OTEC will achieve that level of development. It is impossible to reliably estimate the total amount of time and money the Federal Government could expect to invest in the long-term development, testing, and commercialization of OTEC. The answers to several unsolved, critical technical problems discussed in this report are necessary before such estimates can be made.

It is also impossible with existing information

Figure 4
OTEC Program Schedule

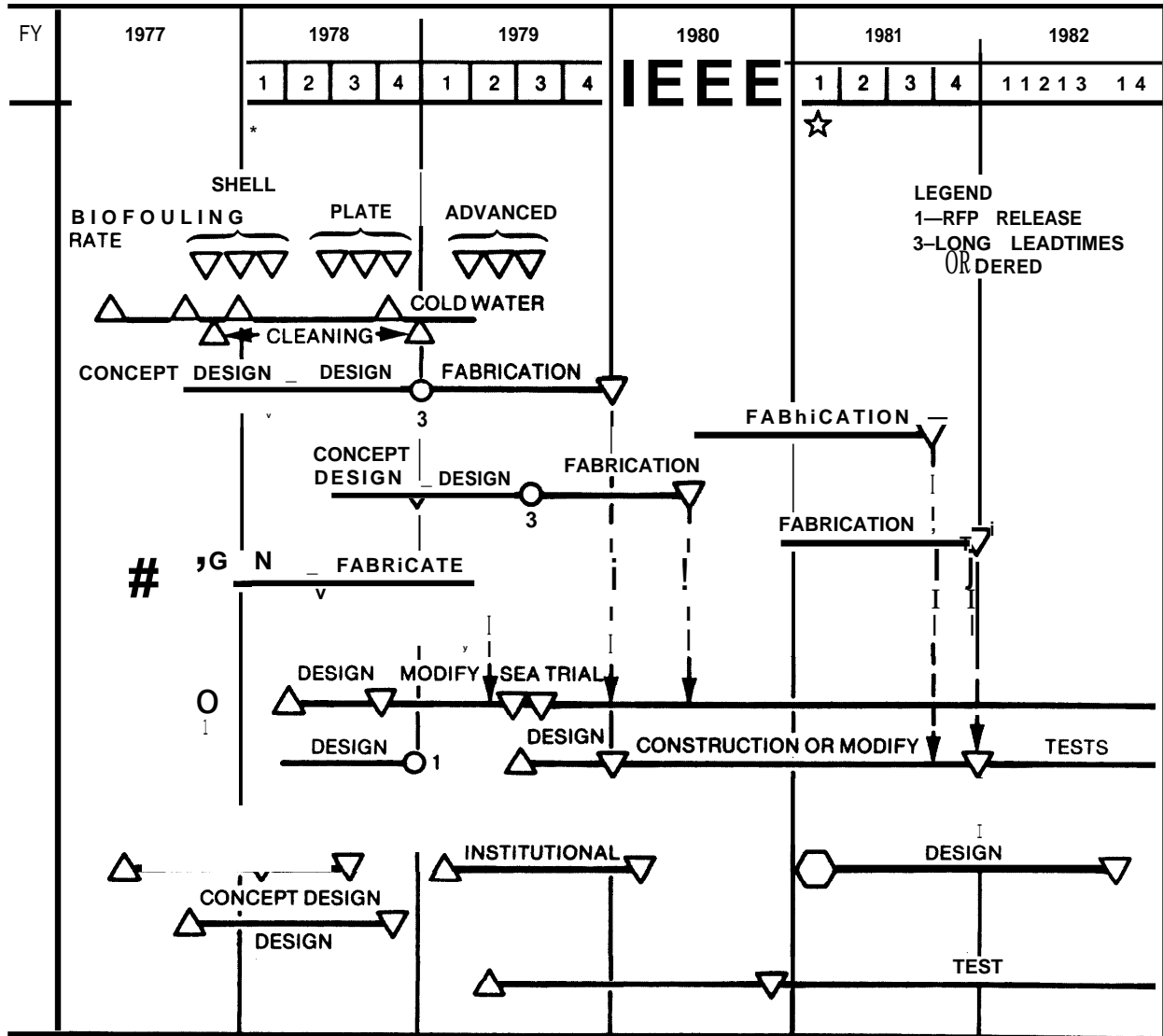

- Programmatic review
 Heat exchangers
 — Bench scale tests
 — Biofouling and corrosion
 — Power modules-1 1 MWe
 5 MWe
 — Power modules-1MMWE
 5 MWe
 — Early 1 MWe test article

- Platforms
 — OTEC-1 (early ocean test platform)
 — OTEC-5 (pilot plant)
 Power cable
 Demonstration
 Open cycle
 — Subsystems tests

Source: Department of Energy.

to determine the future value or potential of OTEC in comparison with other energy technologies, such as fusion, the breeder reactor, solar direct heating and cooling, photovoltaics, windmills, tidal power, and others. The best way to judge the desirability of OTEC development is relative to alternative uses of the required technical, financial, and administrative resources.

In 1977, ERDA projected that, within its research budget for solar electric energy projects, it would allocate about 20 percent of the funding to OTEC through 1986. That projection would make OTEC second only to solar thermal in the amount of research money spent. However, the high funding does not reflect a priority or choice of OTEC as the most promising solar electric technology so much as it reflects the fact that OTEC requires massive pieces of equipment which must be operated and maintained in the marine environment.

The present results of Government-funded research suggest that the investment in OTEC is neither clearly foolish nor clearly desirable. They show only that it is unreasonable to expect that OTEC offers a significant source of new and economical energy before the 21st century.

However, in a future when energy becomes increasingly scarce and expensive, an OTEC which successfully feeds electricity into a grid or provides energy for the production of some commodity could be an important component of the mix of energy alternatives. The exact position of OTEC in the energy supply mix then will depend on the development status, cost, and availability of other alternatives.

However, even if it were safe to assume that OTEC would never compete as a commercial venture it should not be discarded strictly on that basis. There are numerous examples of industries which are supported by the Federal Government because they have been judged to be in the national interest. In addition, some of the equipment which is being developed for OTEC may be usable by the existing power industry for energy conversion and thermal pollution control purposes.

¹Michael Mulcahy, "Ocean Thermal Energy Conversion is One of ERDA's Exciting New Programs," *Sea Technology* 18, (August 1977).

Future Funding Possibilities

Considering energy requirements over a long period of time, such as 50 to 100 years, it is evident that some source of renewable energy must be developed. However, it is too early in the development of OTEC technology to say reliably if OTEC can make a significant contribution to the energy production capability of this country or other countries and if it can do so at a price which is acceptable, with or without Government subsidies. For that reason, there is no obvious amount of money which should be allocated to OTEC research in the future.

Instead, there are three approaches to funding which Congress may wish to consider before appropriating new money for OTEC research:

- a "no funding" approach which implies a pullback of Government involvement, with funding, probably through NSF, of less than a few million dollars a year relegated to basic research and special applications of OTEC principles;
- an "R & D funding" approach which provides funding, in the tens of millions of dollars annually, sufficient to methodically solve all technical problems, prove the feasibility of the concept, and investigate sites, uses of the energy, and impacts;
- a "system development funding" approach which would increase funding rapidly to hundreds of millions of dollars a year with the expressed goal of building an OTEC which would produce a product as soon as possible.

Ideally, funding decisions should be made in the context of an evaluation of the total DOE budget for research on future alternative energy sources. The evaluation should consider for each alternative energy system such factors as:

- the chances that technical problems can be solved;
- the probability that the system will generate net energy;
- the importance of the uses which can be made of the energy;
- the cost of developing a working system;

- the cost of the energy which will be generated; and
- the time required to develop a working system.

No such comparison of alternative energy concepts has been made. Supporters and opponents address each energy concept separately, not relative to each other. Perhaps it is too early in the investigation of most of these alternatives to make meaningful comparisons. However, it is unlikely the Nation can afford system development funding on all the many alternatives which are now being considered. Eventually hard choices will have to be made to determine which alternatives deserve priority funding.

No Funding: If the Congress believes that it is unlikely the technical problems will be solved, that OTEC systems probably will not generate net energy, that the time and cost of solving the problems are excessive, or that OTEC systems will not be competitive, then it may wish to stop program funding for OTEC. If this happens, it is unlikely that OTEC research would stop entirely. Small exploratory projects would probably continue with funding from NSF or private sources. However, it is doubtful that much financial commitment to research would be made by industry if the Government withdrew its support.

A decision to stop program funding for OTEC would mean the elimination of the existing team of OTEC program managers, consultants, and contractors at DOE. It would result in phasing out most current design, testing, and equipment development projects, and additional information about OTEC would be acquired more slowly and principally through industry-sponsored work.

R & D Funding: Since there is currently no evidence that the technical problems relating to OTEC cannot be solved given time and funds, it appears that continued research could lead to development of a workable system. However, it is not known how much money or time would be required to solve the problems. If Congress wishes to attack these problems, funding appropriated at a fairly level amount for the next 5 to 10 years could produce an OTEC program in which solutions to major impeding technical problems are a primary goal and future plans

are tied very closely to the outcome of key research tasks.

The philosophy of R & D funding would be to support research and test projects with a goal of developing a feasible system and providing substantial proof of feasibility by working prototype subsystems, engineering designs, and reasonable cost estimates for construction and operation. This approach would not produce working, large-scale machinery in the near future, but would enable program managers to make more informed decisions on the size, location, materials, construction techniques, and uses of OTEC plants.

Level R & D funding for the OTEC program would probably result in continuation of many of the present OTEC research projects. It would, however, delay schedules proposed by some who envision large-scale use of OTEC for generating electricity or power for manufacturing other products in this century. This approach to funding would keep OTEC as a future energy option and would continue to generate needed information about OTEC at a reasonable cost until choices could be made among the many alternative energy technologies in the Federal research program. It would also result in the establishment of a stable management organization within the Federal Government for initiating projects and evaluating results, and a long-range research capability would be built.

The DOE program for OTEC is currently geared to R & D funding. With this philosophy, requests for rapidly increasing funds are inappropriate until the technology has been proven.

With R & D funding, more specific 5- to 15-year research goals could be set to help clarify program objectives and Congress could establish a procedure for making funding decisions about OTEC on a more informed basis in the future.

More specific research goals could take many forms. Some combination of theoretical analyses, laboratory tests, field surveys and pilot projects would probably be necessary. The following are some examples which have been suggested as short-term goals that could be integrated into an ongoing research program:

- c development of scale models of low-

temperature difference machinery which could be tested at nuclear powerplant out-fall sites.

- development of small-scale shore-based OTEC systems for testing at a suitable island site;
- development of a small floating pilot plant which could be tested at a site where very large temperature differences are available relatively near the surface; and
- s development of a small pilot plant for comparative testing of open and closed cycle systems.

System Development Funding: The cost of proposed OTEC technology is so high that the only way to develop a working prototype plant as soon as possible—that is, to have a large-scale plant at sea producing a product within 10 to 20 years—is to commit large amounts of funds which escalate to hundreds of millions of dollars within a few years.

This is a high-risk approach to funding, not only because it would require billions of dollars, but also because it would probably force a premature choice among several concepts and possible products in order to concentrate on development of one specific system. Although it would include enough testing to gain insights on reliability, cost, maintainability, and online time, this approach could result in skipping long-term testing and environmental studies which would not fit into an accelerated schedule. But it could produce the most rapid demonstration of the one system selected for development. It could also require such a commitment of funds that money would not be allocated to research on other alternative energy sources.

If an OTEC plant were developed quickly, it

is possible there would be a significant, though not necessarily large or economically competitive, impact on the Nation's energy production capability sometime well into the 21st century.

Summary of Government Funding

Since 1972, Government funding for OTEC research has grown from \$85,000 a year to the present budget of \$35 million for the fiscal 1978 program in DOE.

To date, no large amount of private money has been invested in OTEC research and development, and it is likely that Government funding will be the major support for any further work in the foreseeable future.

It is too early in the development of OTEC technology to say definitely that OTEC can or cannot make a significant contribution to the energy production capability of this country. For that reason, there is no obvious amount of money which should be appropriated for further research.

In the long term, decisions about funding are ideally made in the context of an evaluation of the total DOE budget for research on future alternative energy sources. In the absence of such a comparison of alternative energy concepts, a "no funding" approach could be used to eliminate the OTEC program and reduce future efforts to basic research and investigation of special applications; an "R & D funding" approach could be used to keep OTEC as a future energy option while generating solutions to important technical problems at a reasonable cost; or a "system development funding" approach could be used to attempt to develop a large-scale working prototype of one specific OTEC system as soon as possible.